

SMST 20WUU NB

Linear bushing

TYPE: Shaft guidance systems, Linear bushing, With flange, Oval type, double length, Type SMT..W, Asian standard, Corrosion resistance, Stainless steel cage (NB)

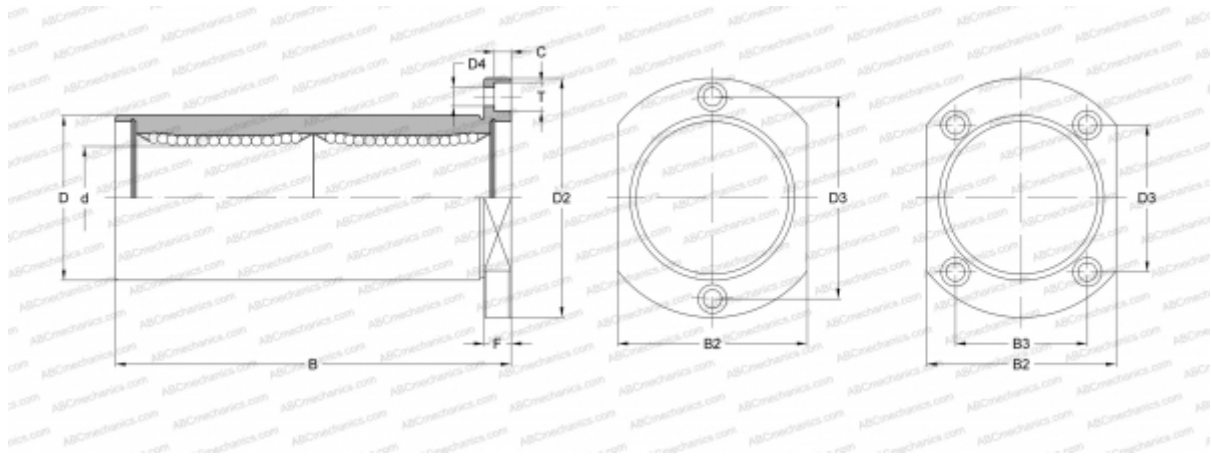

Technical specification

DIMENSIONS, MM

d	20,000
D	32,000
B	80,000
D2	54,000
D3	36,000
D4	5,500
B2	38,000
B3	24,000
T	9,000
C	5,100
F	8

WEIGHT, KG 0,247

MANUFACTURER [NB](#)