

SMFC 8G NB

Linear bushing

TYPE: Shaft guidance systems, Linear bushing, Middle flange location, Circular type, Type SMFC, Asian standard, Plastic cage (NB)

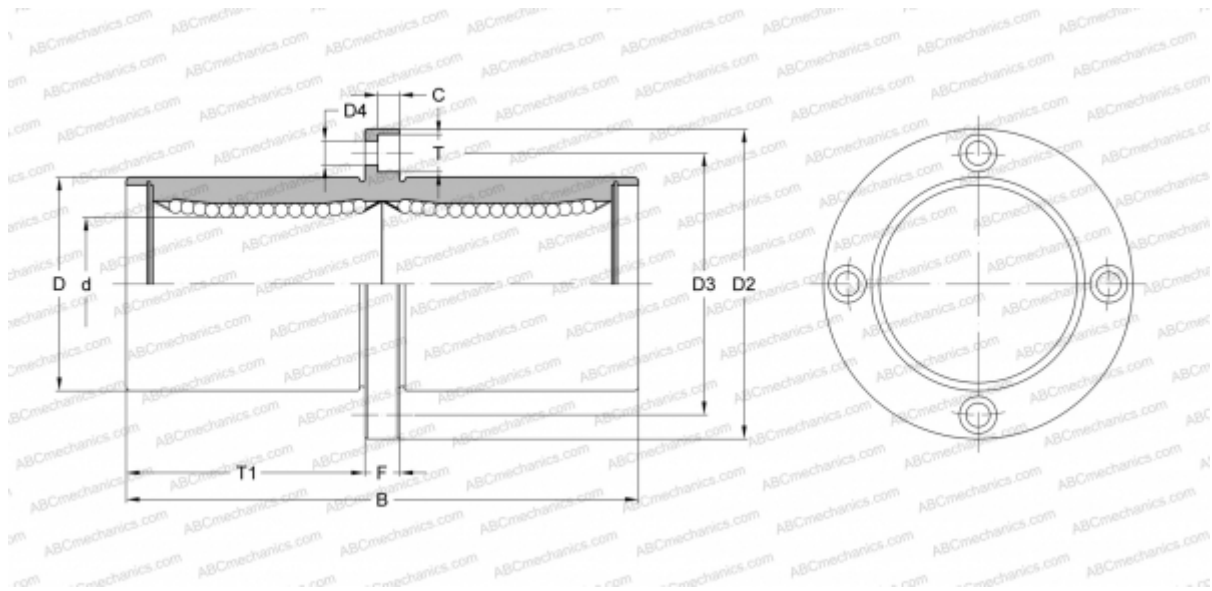

Technical specification

DIMENSIONS, MM

d	8,000
D	15,000
B	45,000
D2	32,000
D3	24,000
D4	3,500
T	6,000
T1	20,000
C	3,100
F	5

WEIGHT, KG 0,051

MANUFACTURER [NB](#)