

## SMFC 13G NB

Linear bushing

TYPE: Shaft guidance systems, Linear bushing, Middle flange location, Circular type, Type SMFC, Asian standard, Plastic cage (NB)

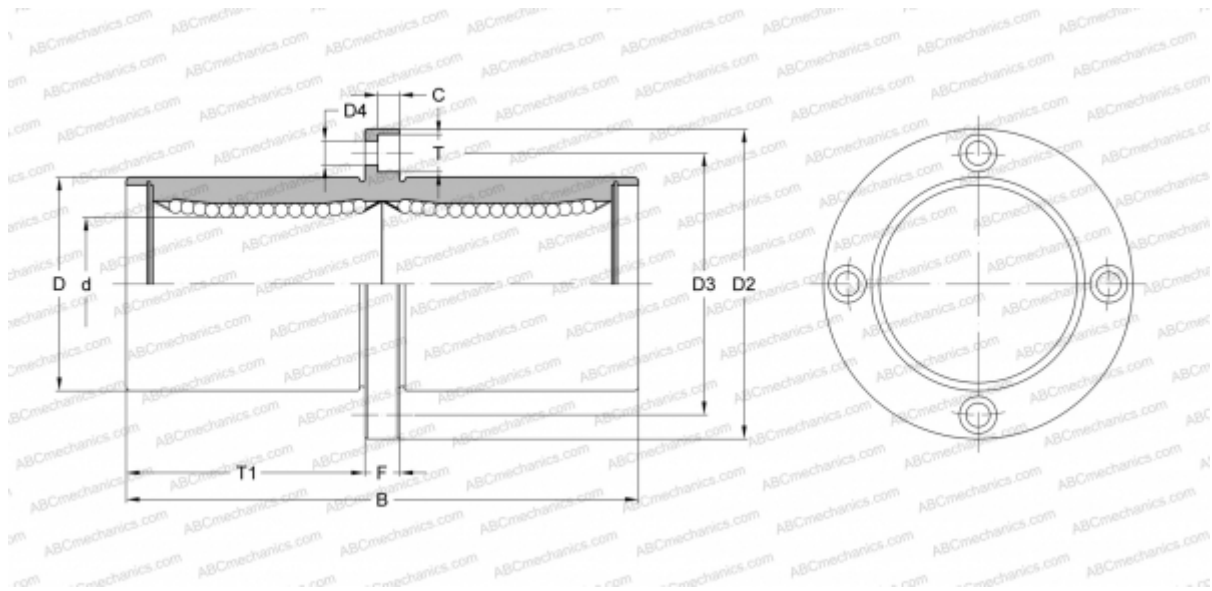

### Technical specification

#### DIMENSIONS, MM

d	13,000
D	23,000
B	61,000
D2	43,000
D3	33,000
D4	4,500
T	7,500
T1	27,500
C	4,100
F	6

**WEIGHT, KG** 0,130

**MANUFACTURER** [NB](#)