

SMSFC 6 NB

Linear bushing

TYPE: Shaft guidance systems, Linear bushing, Middle flange location, Circular type, Type SMFC, Asian standard, Corrosion resistance, Stainless steel cage (NB)

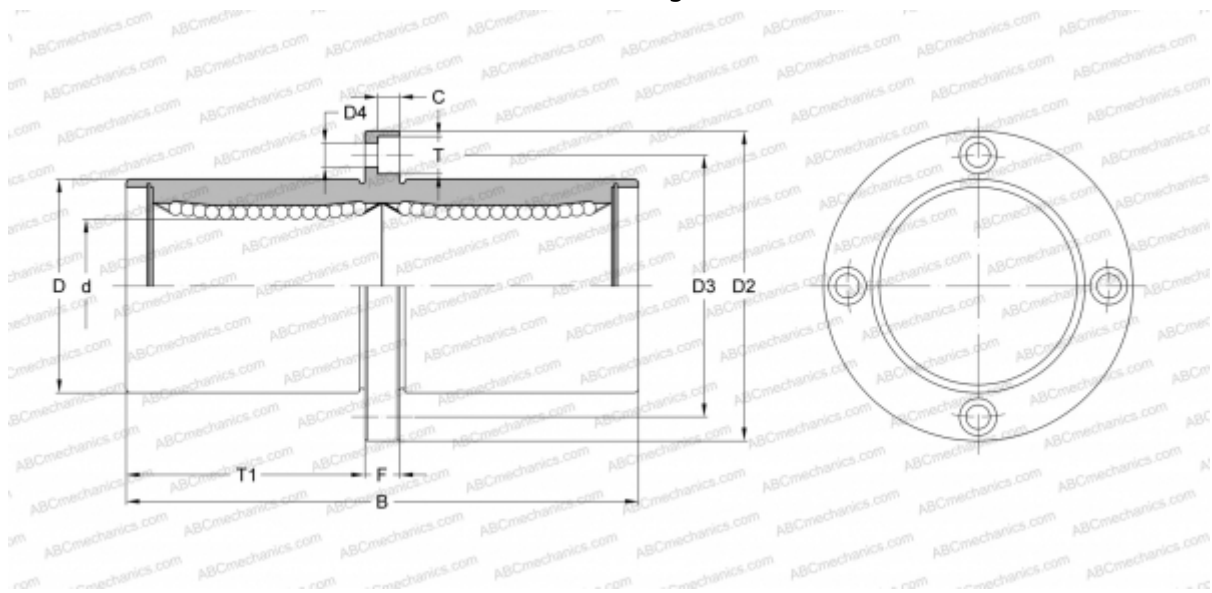

Technical specification

DIMENSIONS, MM

d	6,000
D	12,000
B	35,000
D2	28,000
D3	20,000
D4	3,500
T	6,000
T1	15,000
C	3,100
F	5

WEIGHT, KG 0,031

MANUFACTURER [NB](#)