

## SMF 16GWUU-E NB

Linear bushing

TYPE: Shaft guidance systems, Linear bushing, Pilot flange location, Circular type, double length, Type SMF..W..E, Asian standard, Plastic cage (NB)

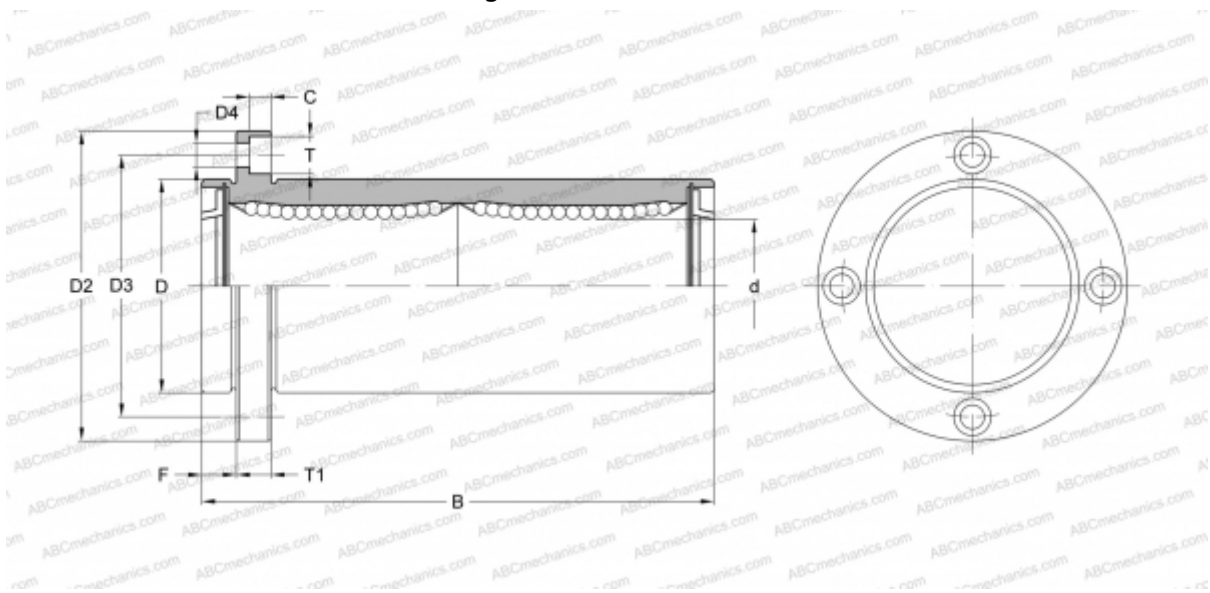

### Technical specification

#### DIMENSIONS, MM

d	16,000
D	28,000
B	70,000
D2	48,000
D3	38,000
D4	4,500
T	7,500
T1	6,000
C	4,100
F	6

**WEIGHT, KG** 0,190

**MANUFACTURER** [NB](#)