

SMK 12WUU-E NB

Linear bushing

TYPE: Shaft guidance systems, Linear bushing, Pilot flange location, Square type, double length, Type SMK..W..E, Asian standard, Steel cage (NB)

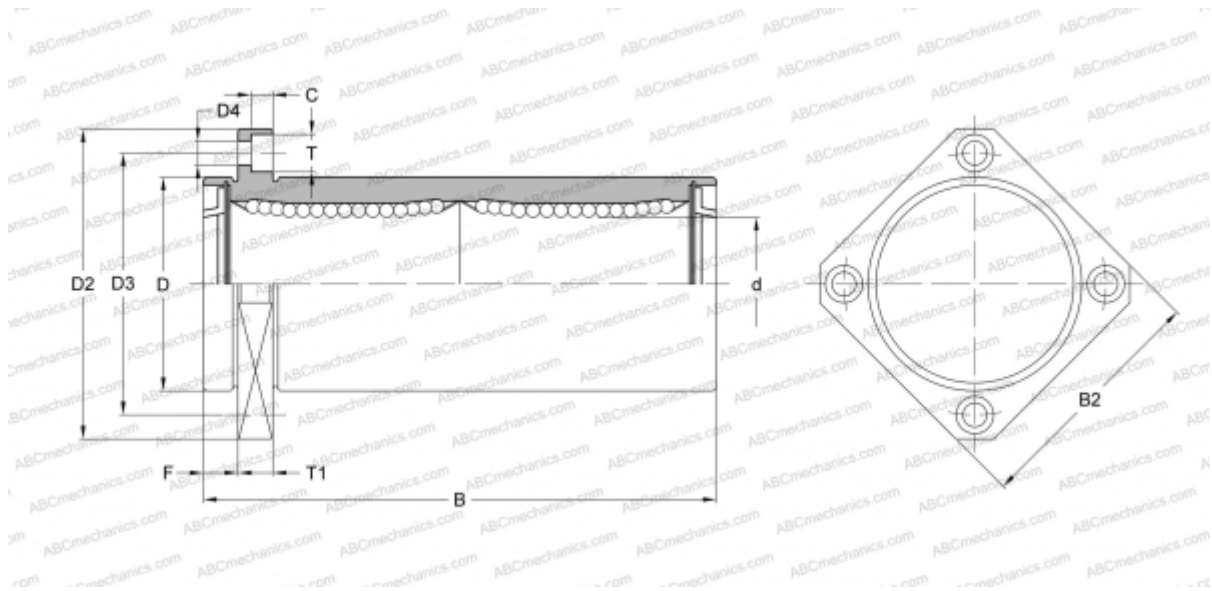

Technical specification

DIMENSIONS, MM

d	12,000
D	21,000
B	57,000
D2	42,000
D3	32,000
D4	4,500
B2	32,000
T	7,500
T1	6,000
C	4,100
F	6

WEIGHT, KG 0,090

MANUFACTURER [NB](#)