

## TRF 6UU NB

Linear bushing

TYPE: Shaft guidance systems, Linear bushing, With flange, Circular type, three length, Type TRF, Asian standard, Steel cage (NB)

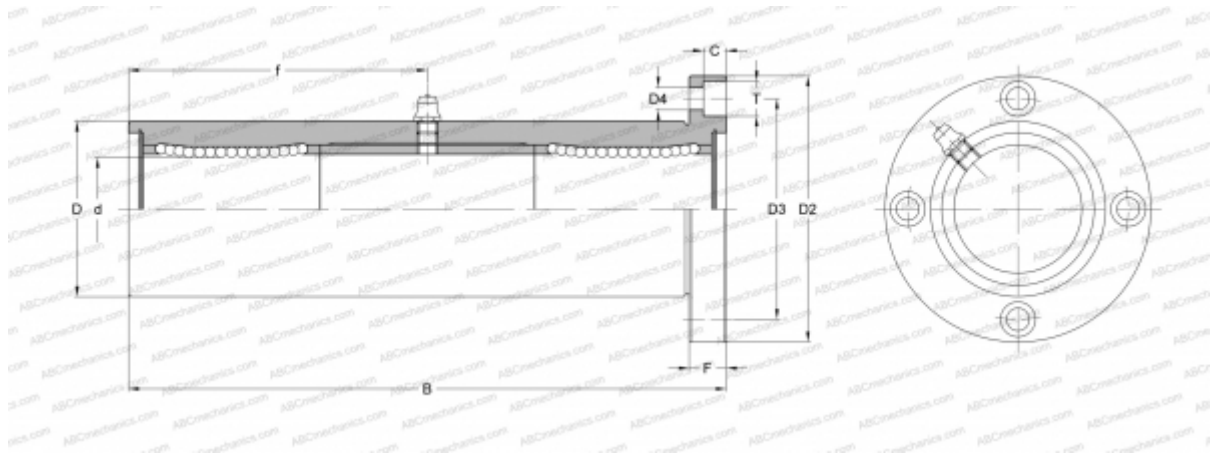

### Technical specification

#### DIMENSIONS, MM

d	6,000
D	15,000
B	51,000
D2	32,000
D3	24,000
D4	3,500
T	6,000
f	20,500
C	3,100
F	5

**WEIGHT, KG** 0,066

**MANUFACTURER** [NB](#)