

## TRF 8UU NB

Linear bushing

TYPE: Shaft guidance systems, Linear bushing, With flange, Circular type, three length, Type TRF, Asian standard, Steel cage (NB)

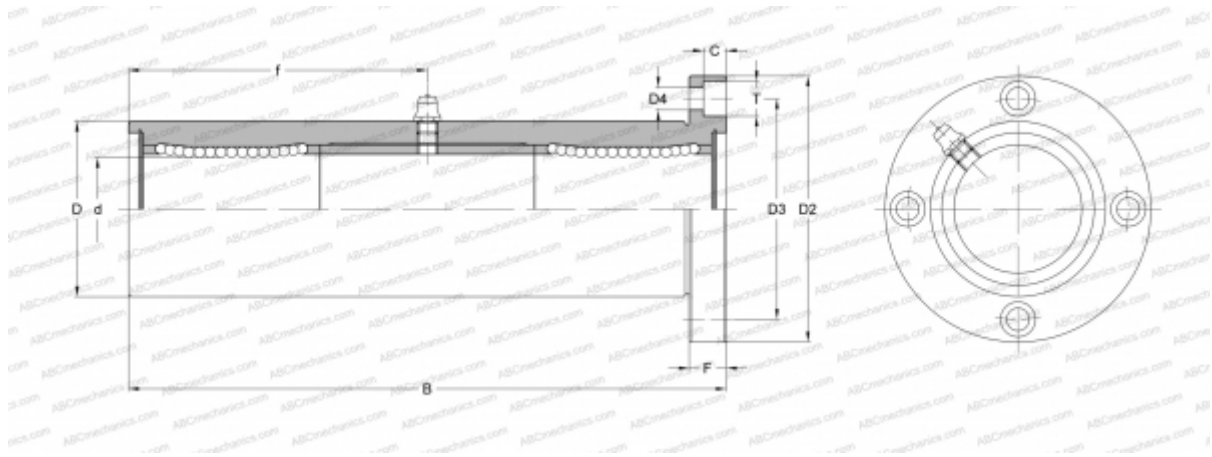

### Technical specification

#### DIMENSIONS, MM

d	8,000
D	19,000
B	66,000
D2	40,000
D3	29,000
D4	4,500
T	7,500
f	29,000
C	4,100
F	6

**WEIGHT, KG** 0,135

**MANUFACTURER** [NB](#)