

TRF 12UU NB

Linear bushing

TYPE: Shaft guidance systems, Linear bushing, With flange, Circular type, three length, Type TRF, Asian standard, Steel cage (NB)

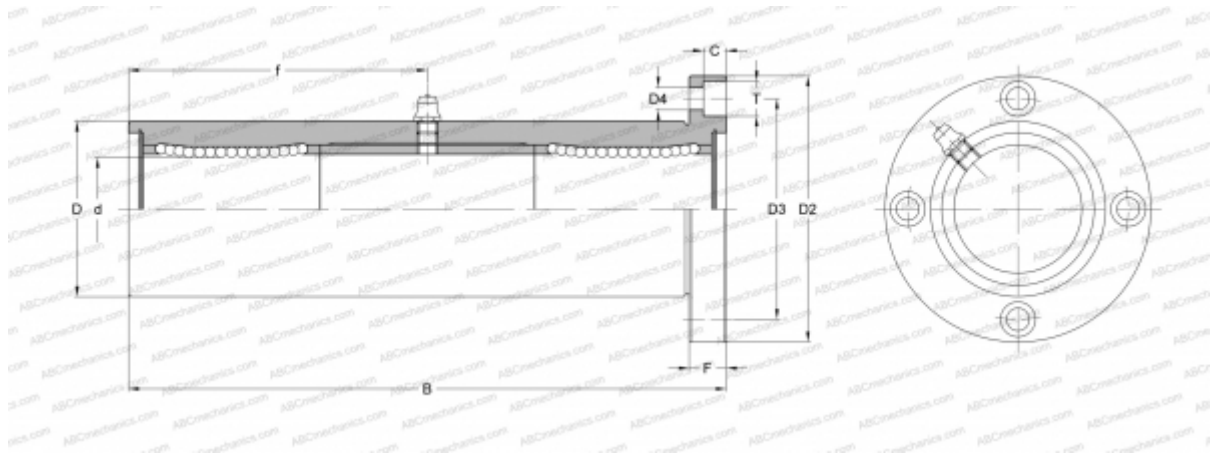

Technical specification

DIMENSIONS, MM

d	12,000
D	26,000
B	84,000
D2	46,000
D3	36,000
D4	4,500
T	7,500
f	41,000
C	4,100
F	6

WEIGHT, KG 0,248

MANUFACTURER [NB](#)