

TRF 13UU NB

Linear bushing

TYPE: Shaft guidance systems, Linear bushing, With flange, Circular type, three length, Type TRF, Asian standard, Steel cage (NB)

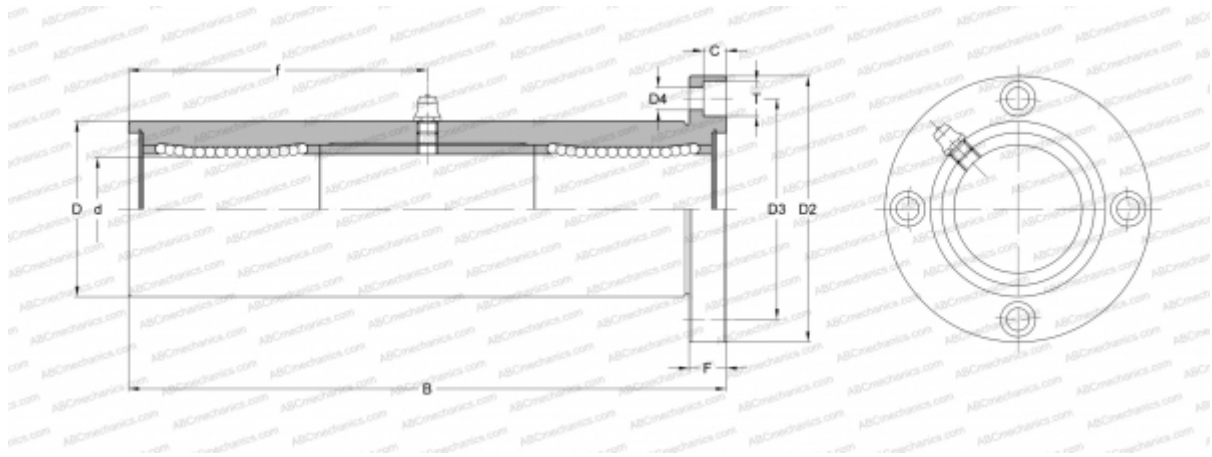

Technical specification

DIMENSIONS, MM

d	13,000
D	28,000
B	90,000
D2	48,000
D3	38,000
D4	4,500
T	7,500
f	45,000
C	4,100
F	6

WEIGHT, KG 0,308

MANUFACTURER [NB](#)