

TRF 20UU NB

Linear bushing

TYPE: Shaft guidance systems, Linear bushing, With flange, Circular type, three length, Type TRF, Asian standard, Steel cage (NB)

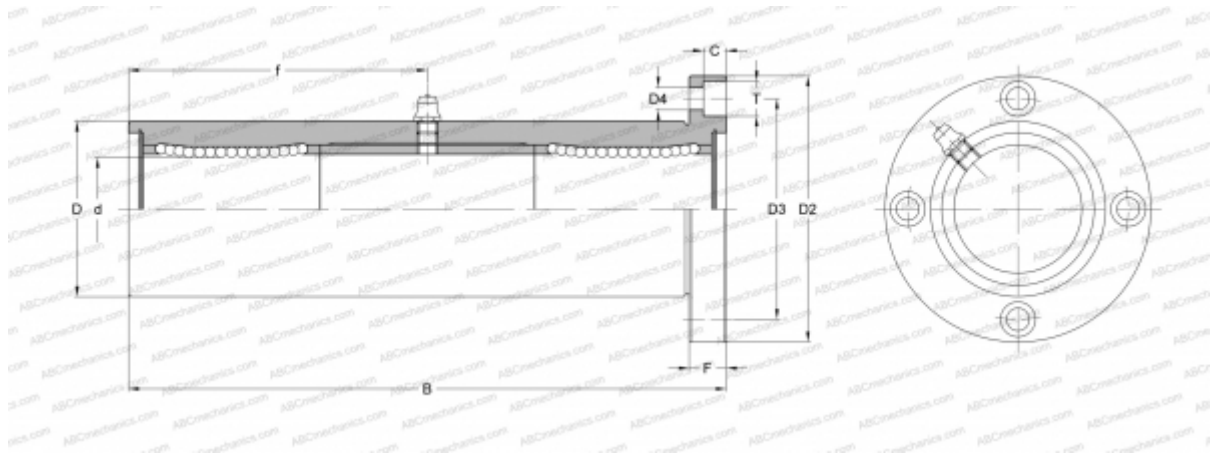

Technical specification

DIMENSIONS, MM

d	20,000
D	40,000
B	118,000
D2	62,000
D3	51,000
D4	5,500
T	9,000
f	59,000
C	5,100
F	8

WEIGHT, KG 0,752

MANUFACTURER [NB](#)