

## TRF 35UU NB

Linear bushing

TYPE: Shaft guidance systems, Linear bushing, With flange, Circular type, three length, Type TRF, Asian standard, Steel cage (NB)

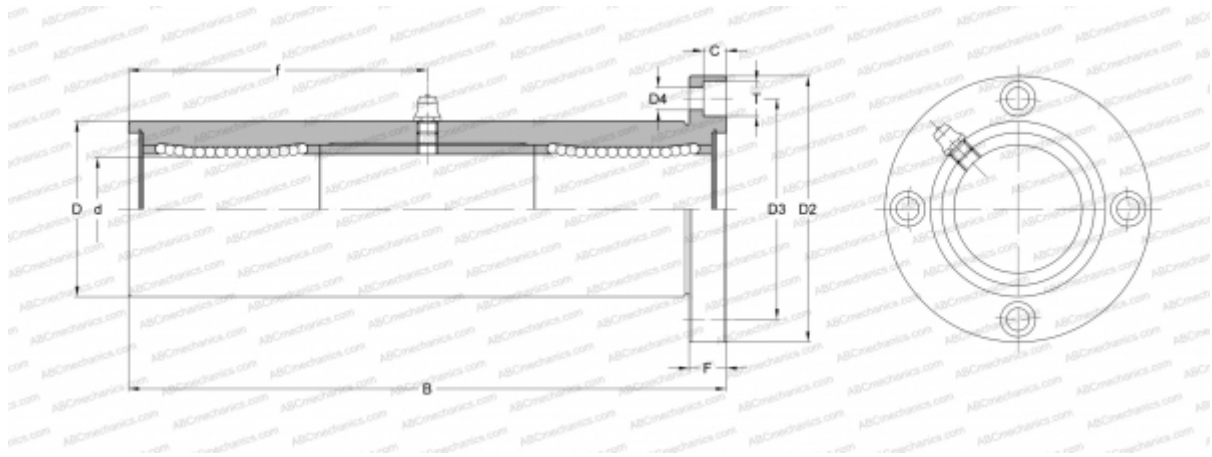

### Technical specification

#### DIMENSIONS, MM

d	35,000
D	60,000
B	200,000
D2	96,000
D3	78,000
D4	9,000
T	14,000
f	100,000
C	8,100
F	13

**WEIGHT, KG** 2,580

**MANUFACTURER** [NB](#)