

## TRF 50UU NB

Linear bushing

TYPE: Shaft guidance systems, Linear bushing, With flange, Circular type, three length, Type TRF, Asian standard, Steel cage (NB)

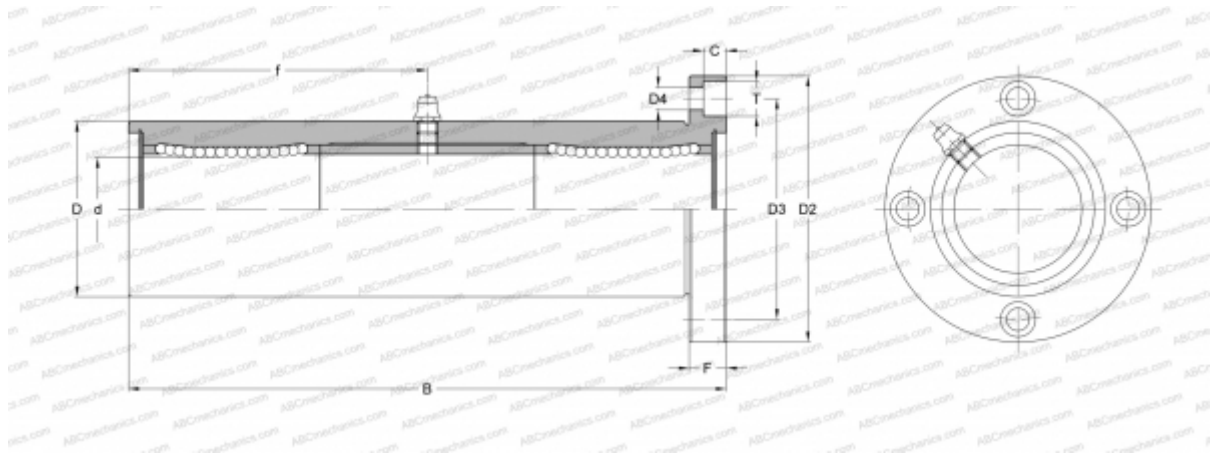

### Technical specification

#### DIMENSIONS, MM

d	50,000
D	85,000
B	290,000
D2	129,000
D3	107,000
D4	11,000
T	17,000
f	145,000
C	11,100
F	18

**WEIGHT, KG** 6,860

**MANUFACTURER** [NB](#)