

TRF 8GUU NB

Linear bushing

TYPE: Shaft guidance systems, Linear bushing, With flange, Circular type, three length, Type TRF, Asian standard, Plastic cage (NB)

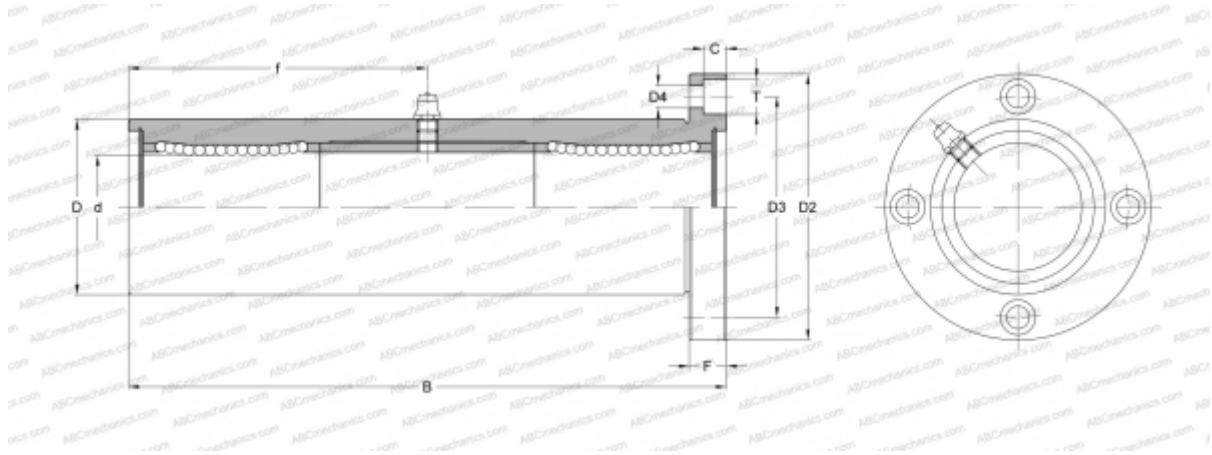

Technical specification

DIMENSIONS, MM

d	8,000
D	19,000
B	66,000
D2	40,000
D3	29,000
D4	4,500
T	7,500
C	4,100
F	6

WEIGHT, KG 0,135

MANUFACTURER [NB](#)