

TRF 10GUU NB

Linear bushing

TYPE: Shaft guidance systems, Linear bushing, With flange, Circular type, three length, Type TRF, Asian standard, Plastic cage (NB)

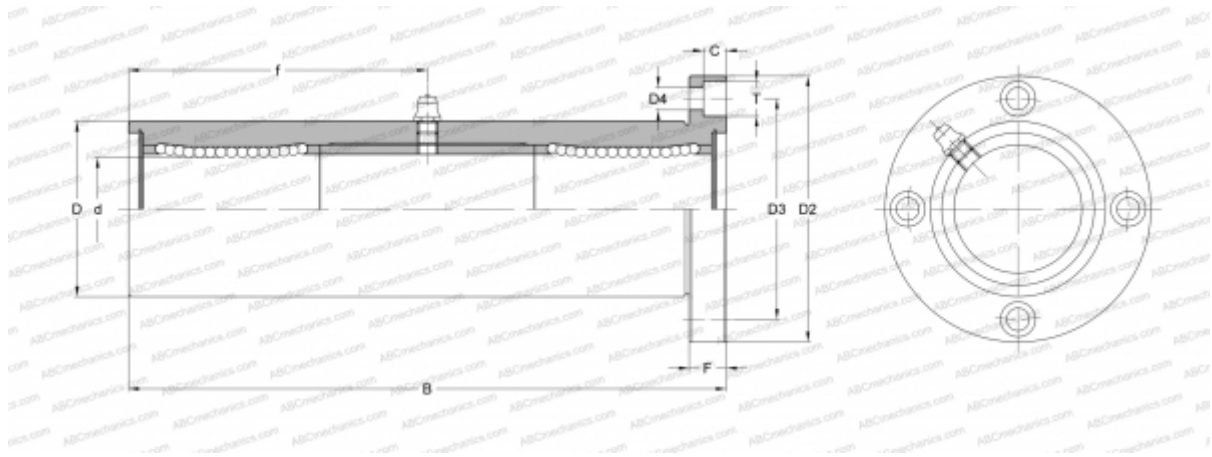

Technical specification

DIMENSIONS, MM

d	10,000
D	23,000
B	80,000
D2	43,000
D3	33,000
D4	4,500
T	7,500
C	4,100
F	6

WEIGHT, KG 0,205

MANUFACTURER [NB](#)