

## TRF 12GUU NB

Linear bushing

TYPE: Shaft guidance systems, Linear bushing, With flange, Circular type, three length, Type TRF, Asian standard, Plastic cage (NB)

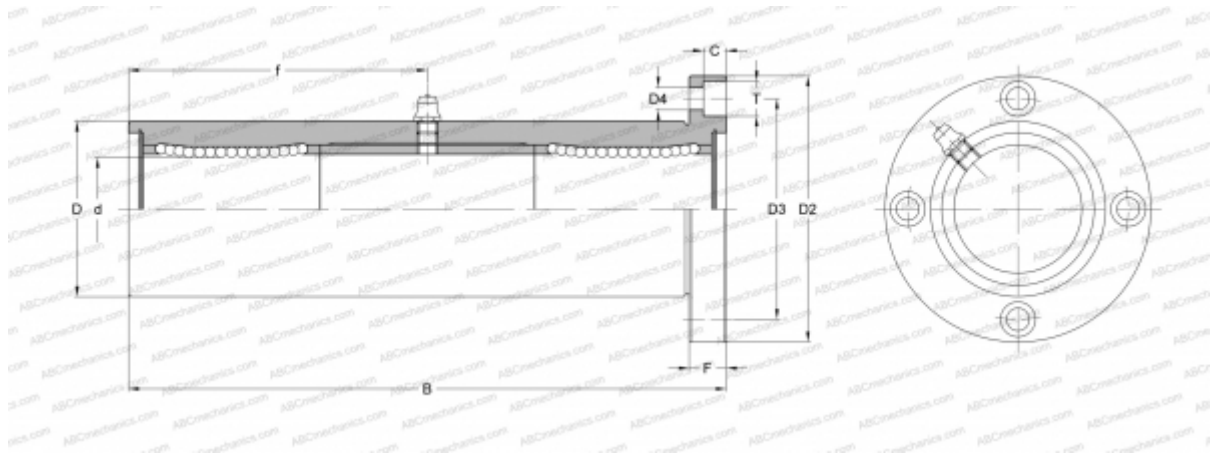

### Technical specification

#### DIMENSIONS, MM

d	12,000
D	26,000
B	84,000
D2	46,000
D3	36,000
D4	4,500
T	7,500
C	4,100
F	6

**WEIGHT, KG** 0,248

**MANUFACTURER** [NB](#)