

TRF 35GUU NB

Linear bushing

TYPE: Shaft guidance systems, Linear bushing, With flange, Circular type, three length, Type TRF, Asian standard, Plastic cage (NB)

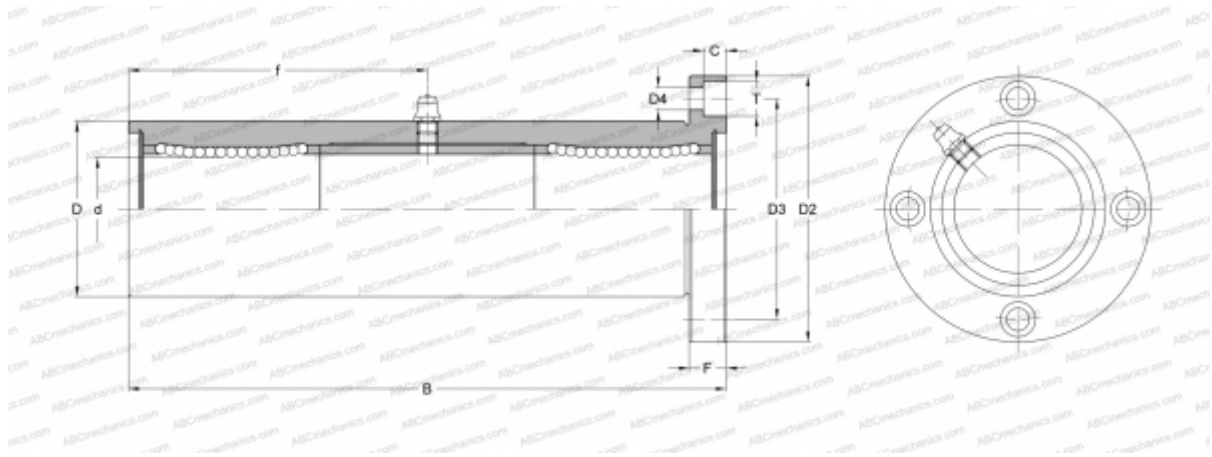

Technical specification

DIMENSIONS, MM

d	35,000
D	60,000
B	200,000
D2	96,000
D3	78,000
D4	9,000
T	14,000
C	8,100
F	13

WEIGHT, KG 2,580

MANUFACTURER [NB](#)