

## TRK 10UU NB

Linear bushing

TYPE: Shaft guidance systems, Linear bushing, With flange, Square type, three length, Type TRK, Asian standard, Steel cage (NB)

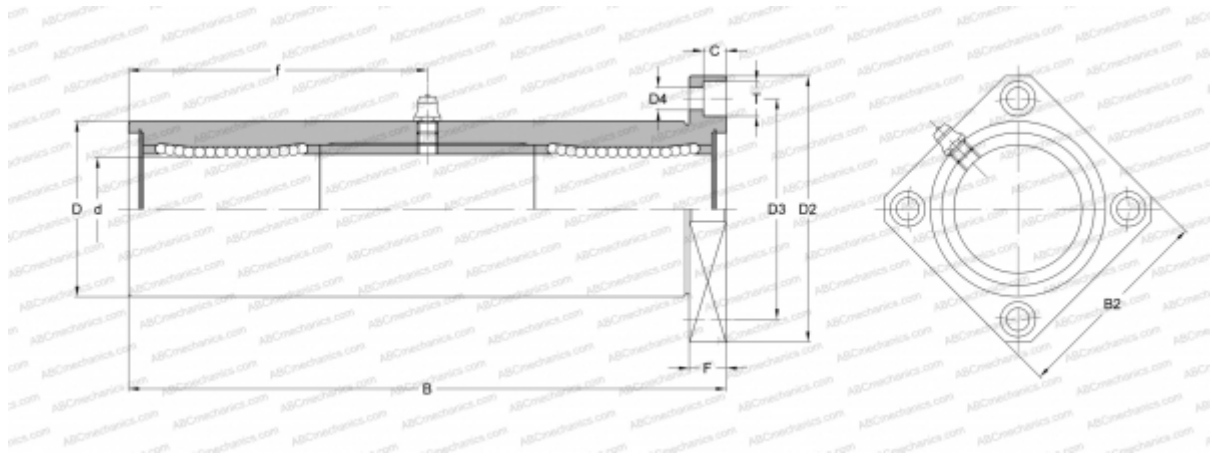

### Technical specification

#### DIMENSIONS, MM

d	10,000
D	23,000
B	80,000
D2	43,000
D3	33,000
D4	4,500
B2	34,000
T	7,500
f	38,000
C	4,100
F	6

**WEIGHT, KG** 0,189

**MANUFACTURER** [NB](#)