

## TRK 30UU NB

Linear bushing

TYPE: Shaft guidance systems, Linear bushing, With flange, Square type, three length, Type TRK, Asian standard, Steel cage (NB)

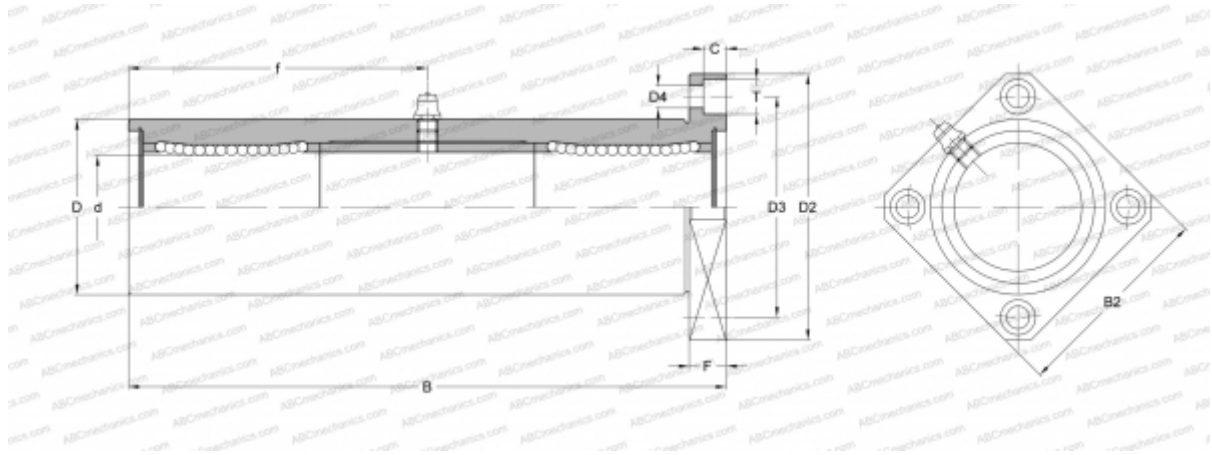

### Technical specification

#### DIMENSIONS, MM

d	30,000
D	52,000
B	182,000
D2	82,000
D3	67,000
D4	6,600
B2	64,000
T	11,000
f	91,000
C	6,100
F	10

**WEIGHT, KG** 1,543

**MANUFACTURER** [NB](#)