

TRK 40UU NB

Linear bushing

TYPE: Shaft guidance systems, Linear bushing, With flange, Square type, three length, Type TRK, Asian standard, Steel cage (NB)

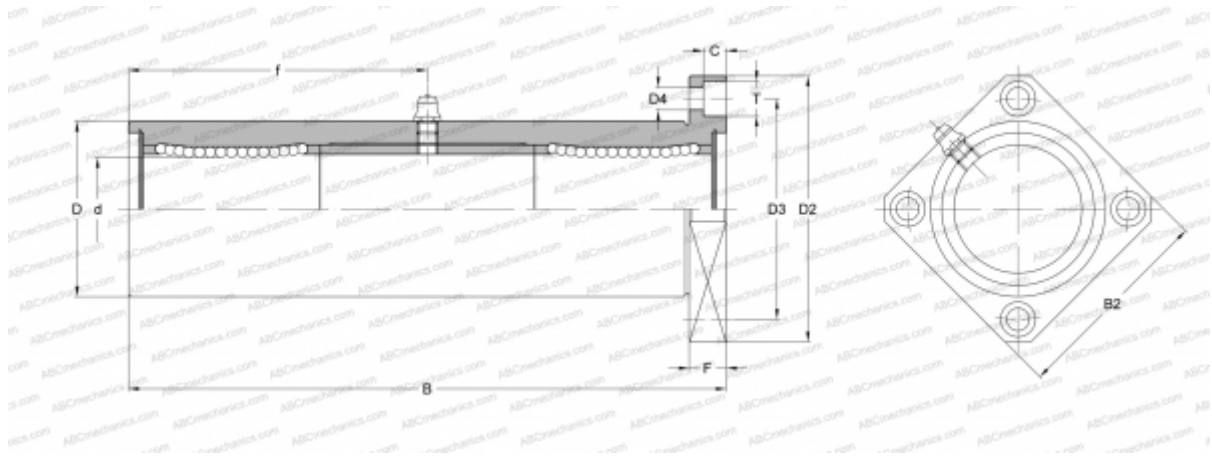

Technical specification

DIMENSIONS, MM

d	40,000
D	65,000
B	230,000
D2	101,000
D3	83,000
D4	9,000
B2	80,000
T	14,000
f	115,000
C	8,100
F	13

WEIGHT, KG 2,510

MANUFACTURER [NB](#)