

## TRK 6GUU NB

Linear bushing

TYPE: Shaft guidance systems, Linear bushing, With flange, Square type, three length, Type TRK, Asian standard, Plastic cage (NB)

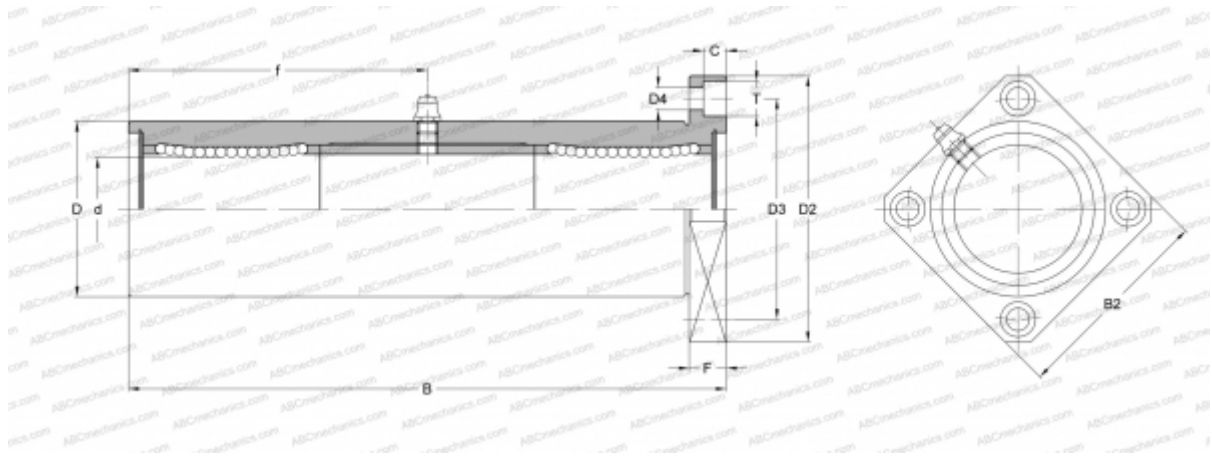

### Technical specification

#### DIMENSIONS, MM

d	6,000
D	15,000
B	51,000
D2	32,000
D3	24,000
D4	3,500
B2	25,000
T	6,000
f	20,500
C	3,100
F	5

**WEIGHT, KG** 0,058

**MANUFACTURER** [NB](#)