

TRK 13GUU NB

Linear bushing

TYPE: Shaft guidance systems, Linear bushing, With flange, Square type, three length, Type TRK, Asian standard, Plastic cage (NB)

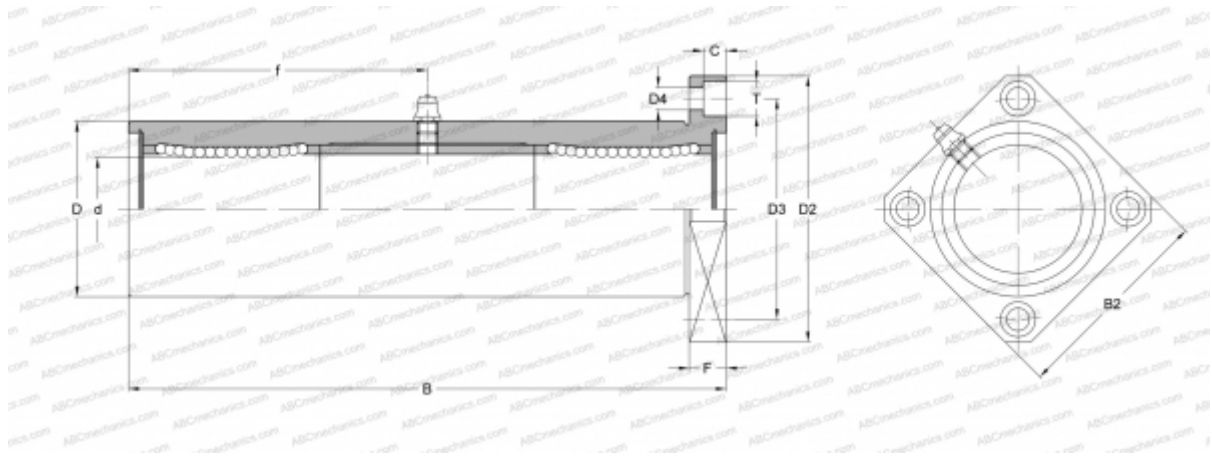

Technical specification

DIMENSIONS, MM

d	13,000
D	28,000
B	90,000
D2	48,000
D3	38,000
D4	4,500
B2	37,000
T	7,500
f	45,000
C	4,100
F	6

WEIGHT, KG 0,286

MANUFACTURER [NB](#)