

TRK 50GUU NB

Linear bushing

TYPE: Shaft guidance systems, Linear bushing, With flange, Square type, three length, Type TRK, Asian standard, Plastic cage (NB)

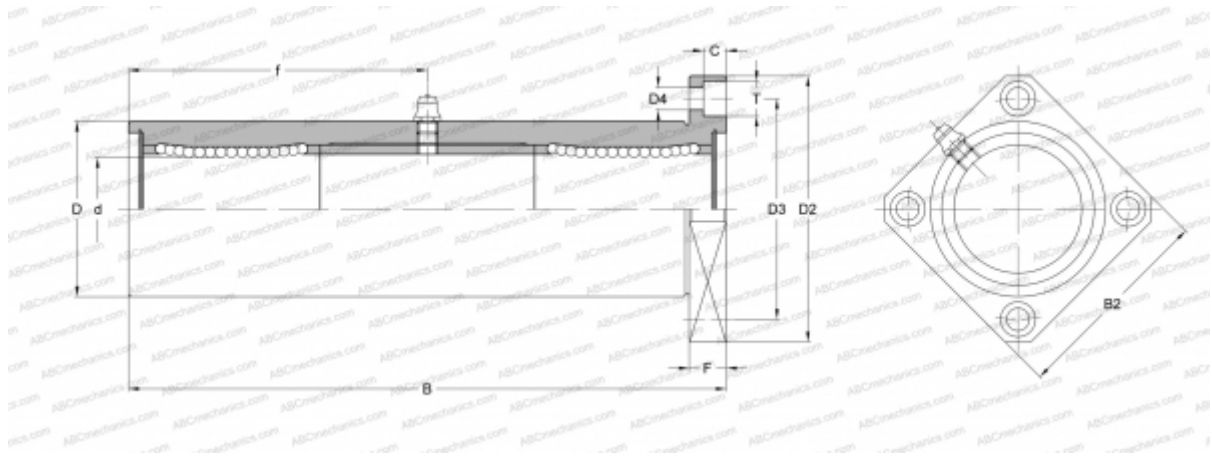

Technical specification

DIMENSIONS, MM

d	50,000
D	85,000
B	290,000
D2	129,000
D3	107,000
D4	11,000
B2	100,000
T	17,000
f	145,000
C	11,100
F	18

WEIGHT, KG 6,400

MANUFACTURER [NB](#)