

KB 10 NB

Linear bushing

TYPE: Shaft guidance systems, Linear bushing, Standard, Close type, Type KB, European standard, Steel cage (NB)

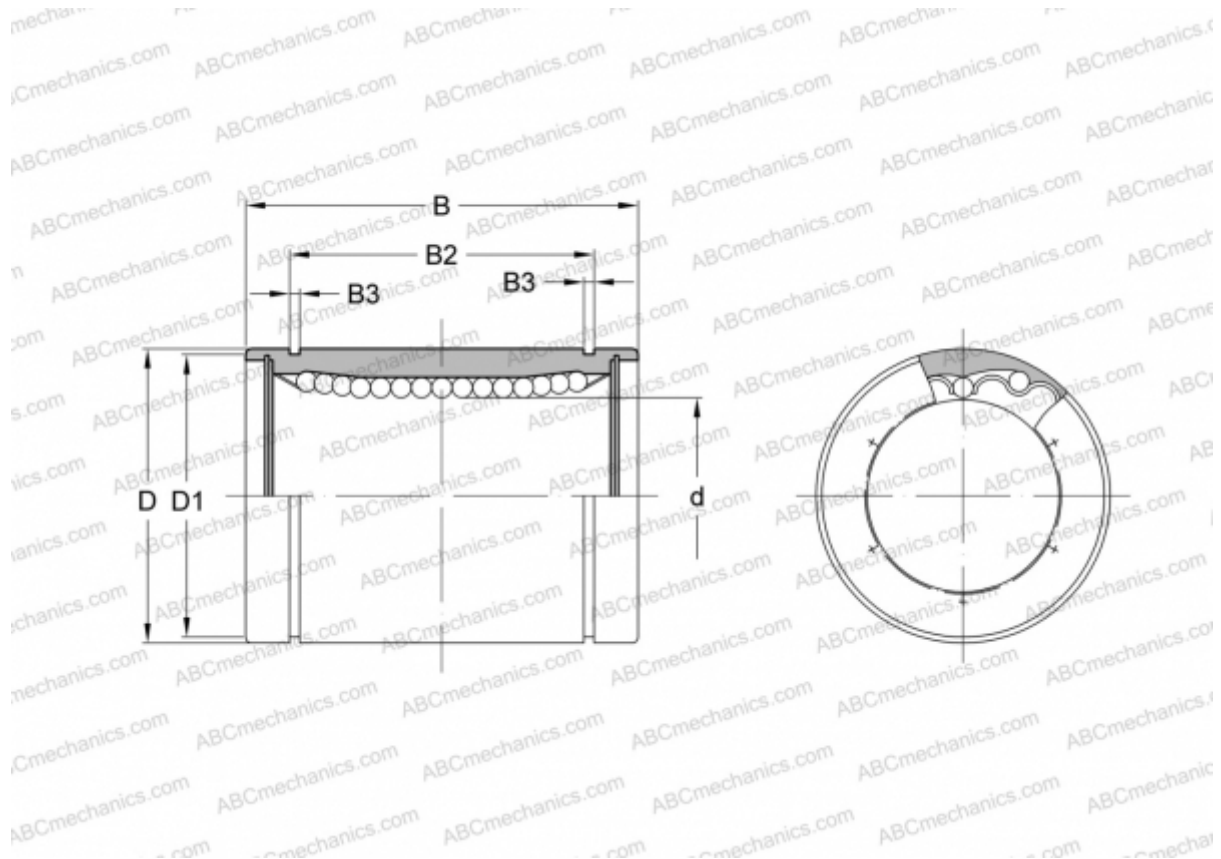

Technical specification

DIMENSIONS, MM

d	10,000
D	19,000
B	29,000
D1	18,000
B2	22,000
B3	1,300

WEIGHT, KG 0,036

MANUFACTURER [NB](#)