

## KB 30 NB

Linear bushing

TYPE: Shaft guidance systems, Linear bushing, Standard, Close type, Type KB, European standard, Steel cage (NB)

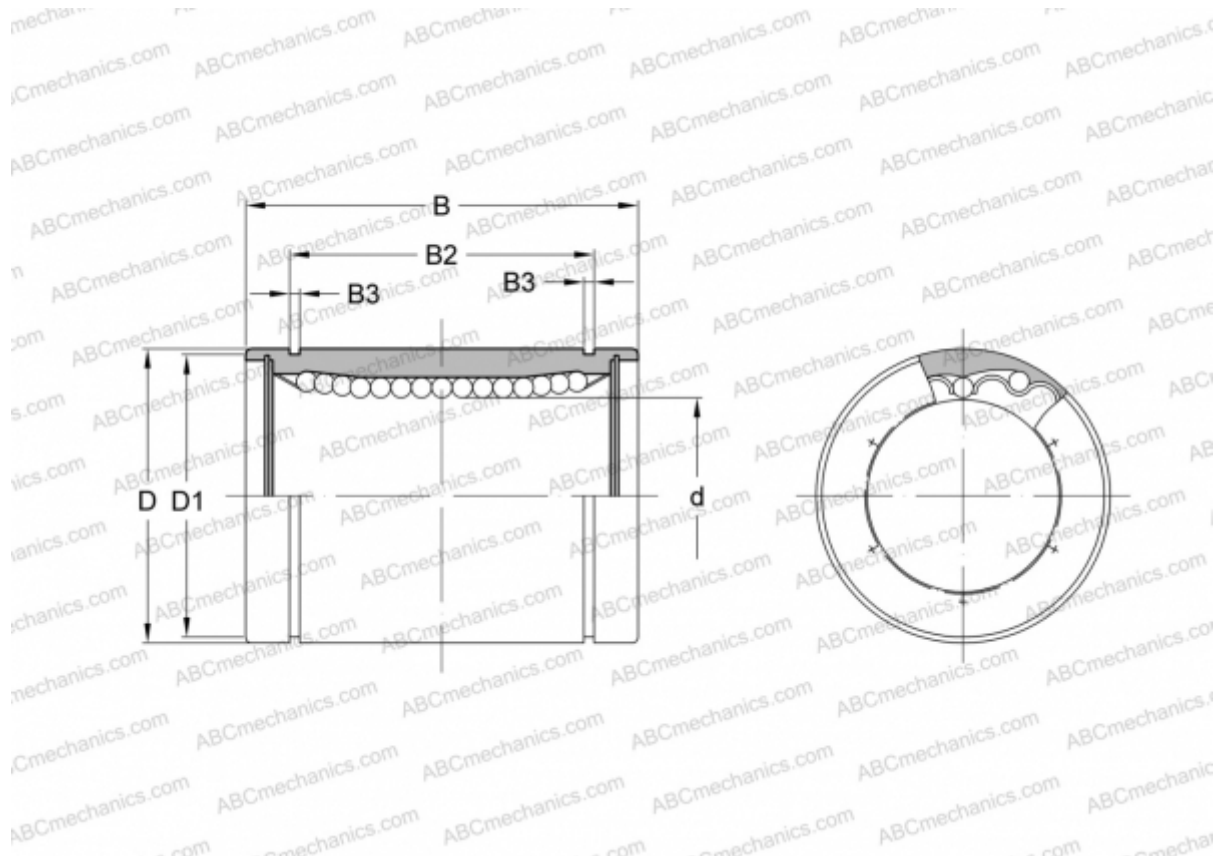

### Technical specification

#### DIMENSIONS, MM

d	30,000
D	47,000
B	68,000
D1	44,500
B2	52,100
B3	1,850

**WEIGHT, KG** 0,360

**MANUFACTURER** [NB](#)