

## KB 4G NB

Linear bushing

TYPE: Shaft guidance systems, Linear bushing, Standard, Close type, Type KB, European standard, Plastic cage (NB)

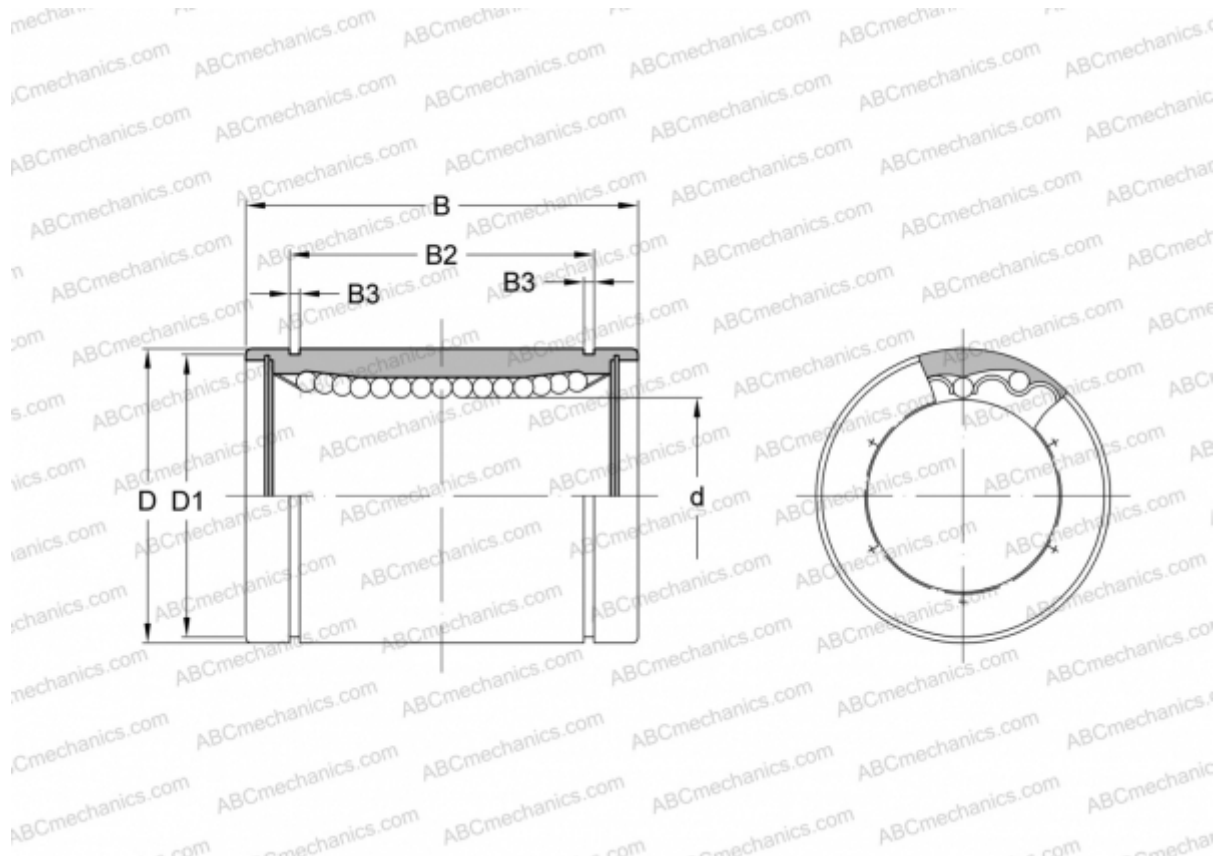

### Technical specification

#### DIMENSIONS, MM

d	4,000
D	8,000
B	12,000

**WEIGHT, KG** 0,002

**MANUFACTURER** [NB](#)