

KB 5G NB

Linear bushing

TYPE: Shaft guidance systems, Linear bushing, Standard, Close type, Type KB, European standard, Plastic cage (NB)

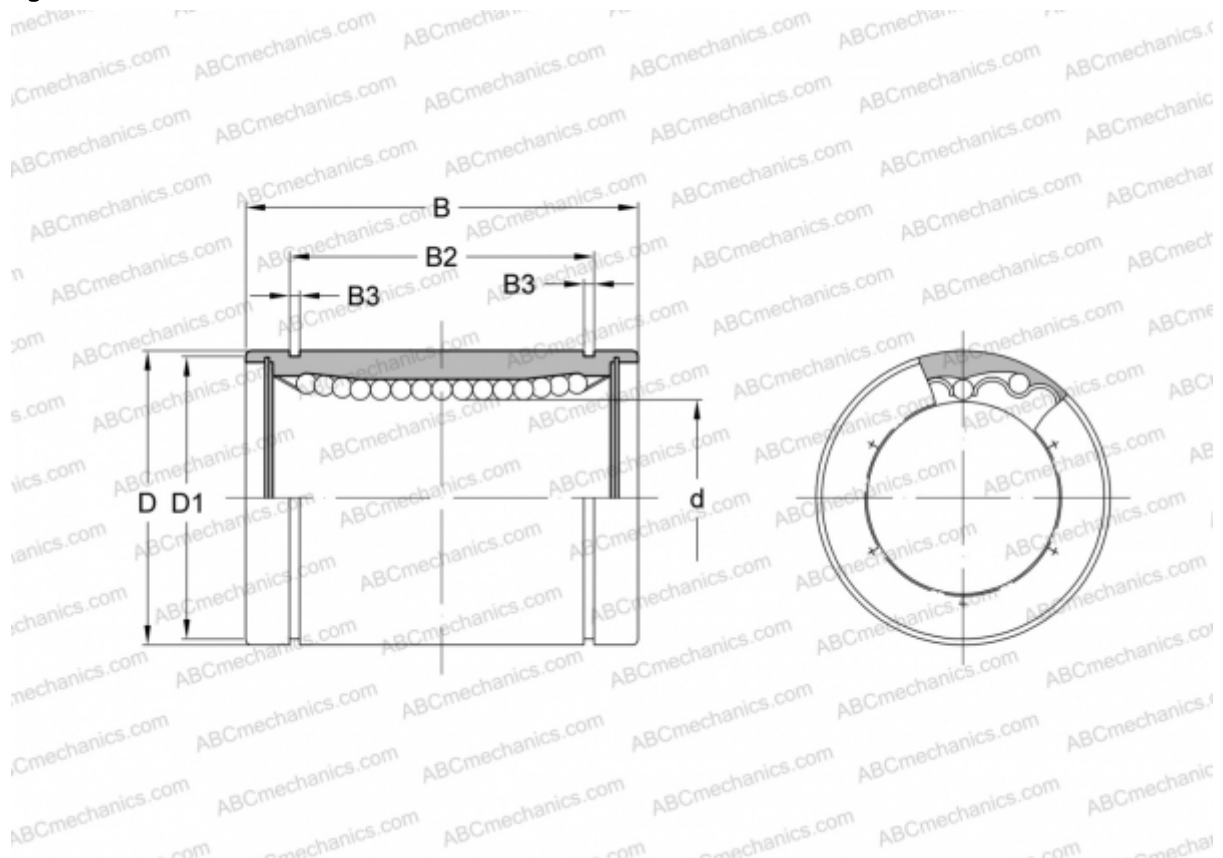

Technical specification

DIMENSIONS, MM

d	5,000
D	12,000
B	22,000
D1	11,500
B2	14,500
B3	1,100

WEIGHT, KG 0,011

MANUFACTURER [NB](#)