

KB 12G NB

Linear bushing

TYPE: Shaft guidance systems, Linear bushing, Standard, Close type, Type KB, European standard, Plastic cage (NB)

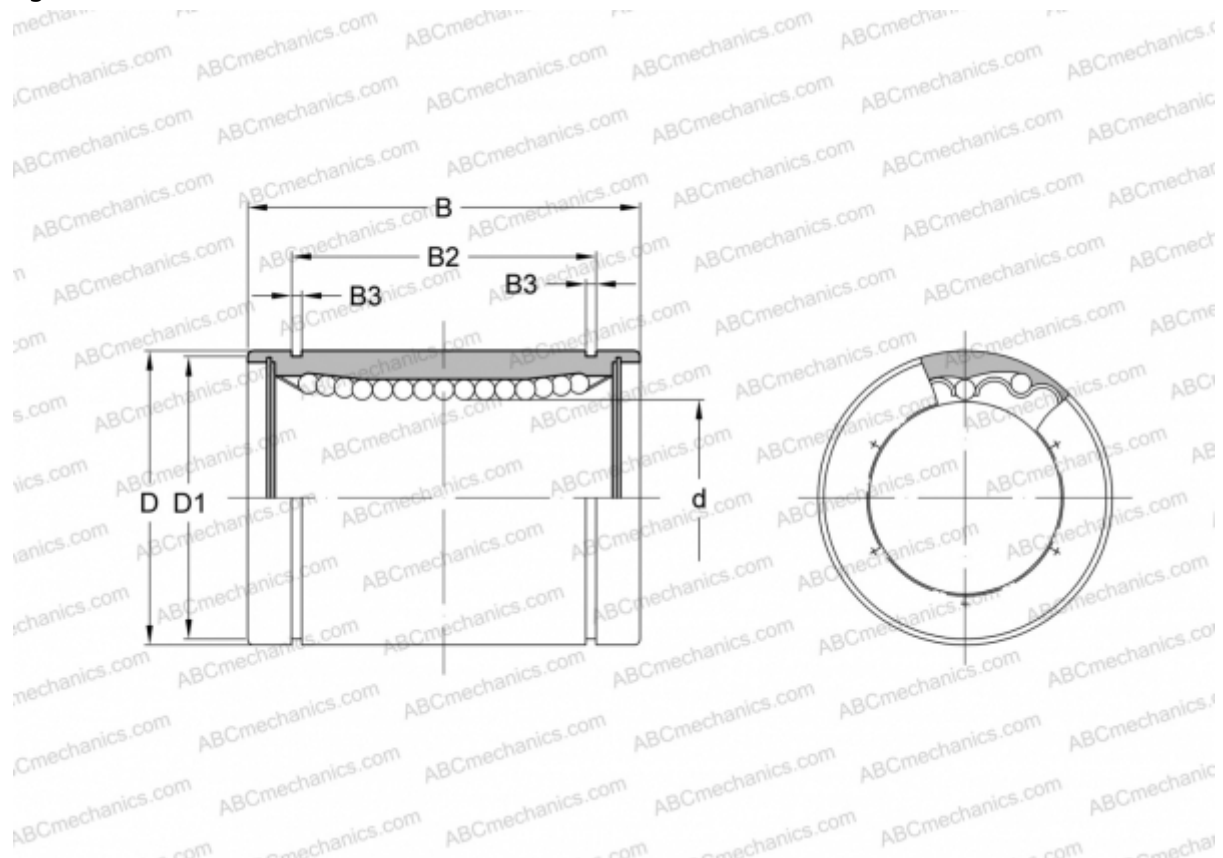

Technical specification

DIMENSIONS, MM

d	12,000
D	22,000
B	32,000
D1	21,000
B2	22,900
B3	1,300

WEIGHT, KG 0,045

MANUFACTURER [NB](#)