

KB 25G NB

Linear bushing

TYPE: Shaft guidance systems, Linear bushing, Standard, Close type, Type KB, European standard, Plastic cage (NB)

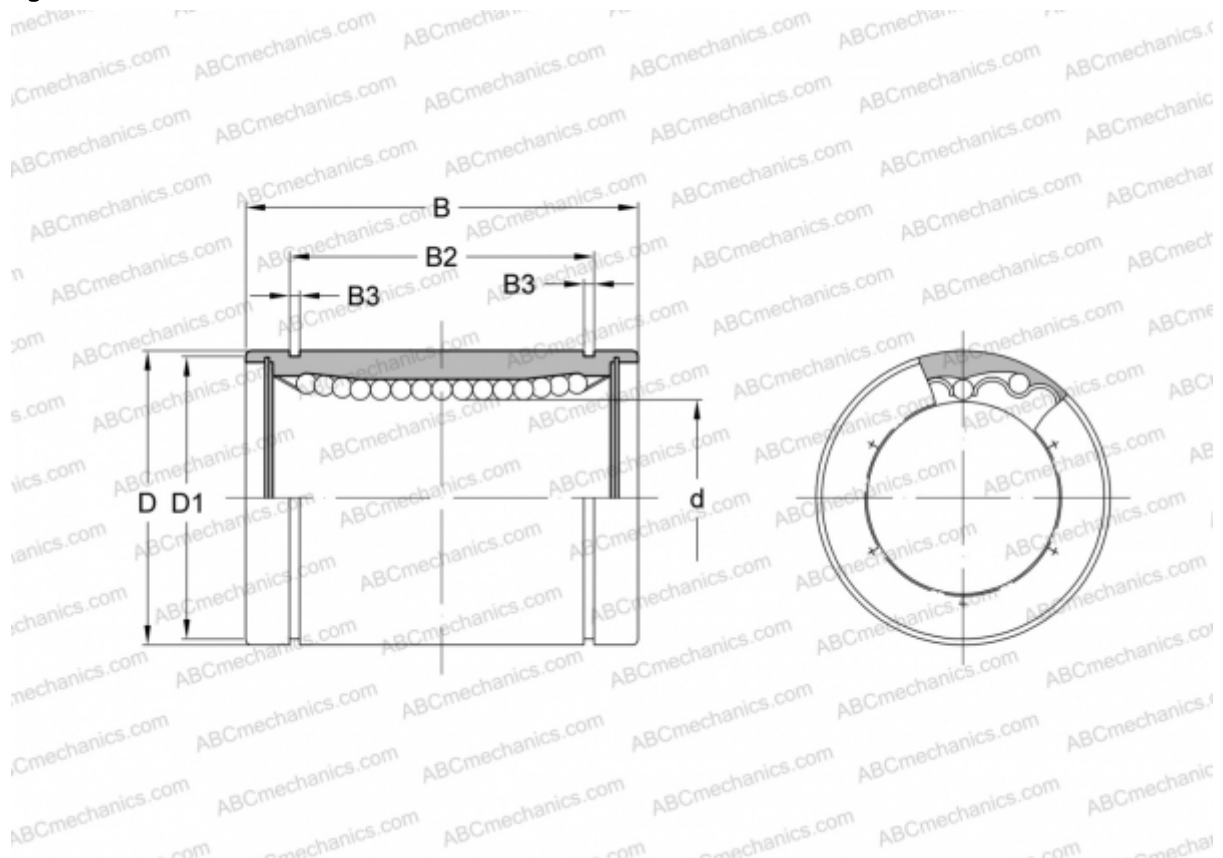

Technical specification

DIMENSIONS, MM

d	25,000
D	40,000
B	58,000
D1	37,500
B2	44,100
B3	1,850

WEIGHT, KG 0,235

MANUFACTURER [NB](#)