

KB 40G NB

Linear bushing

TYPE: Shaft guidance systems, Linear bushing, Standard, Close type, Type KB, European standard, Plastic cage (NB)

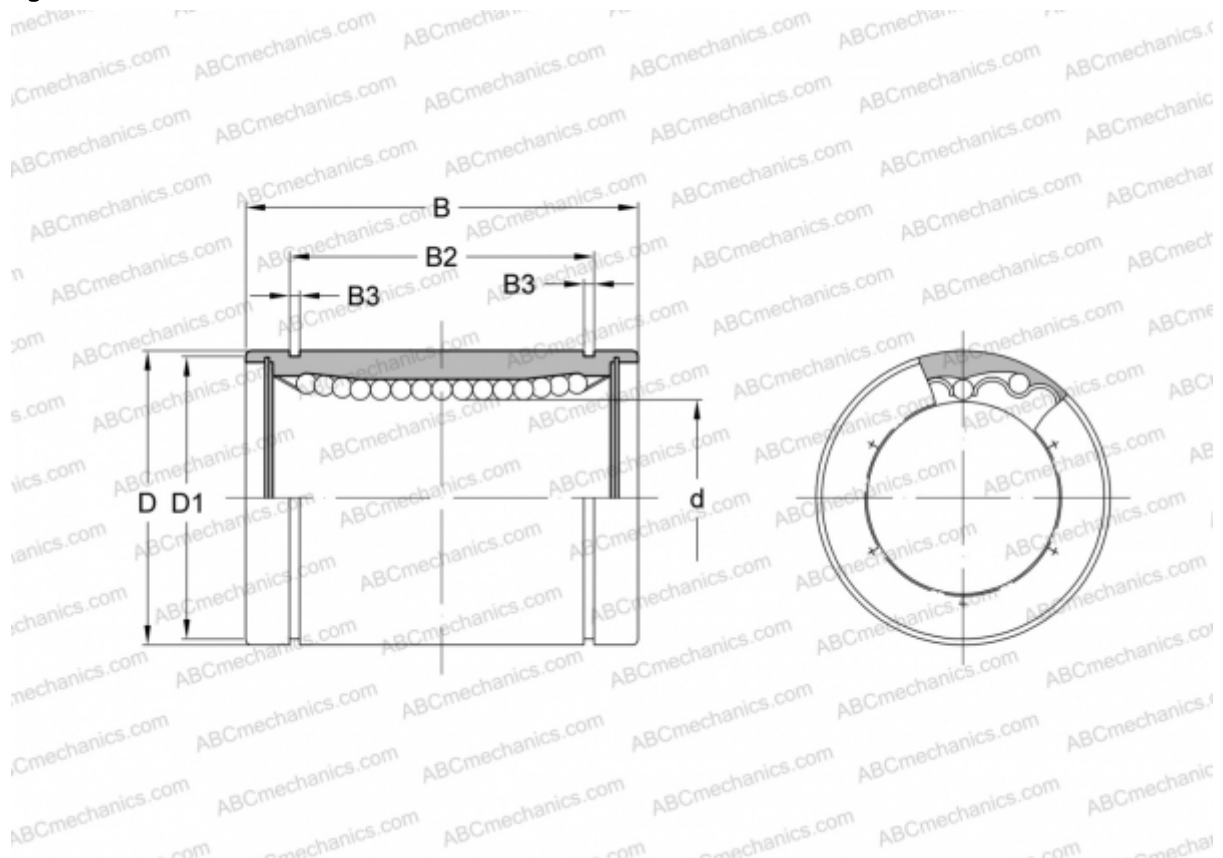

Technical specification

DIMENSIONS, MM

d	40,000
D	62,000
B	80,000
D1	59,000
B2	60,600
B3	2,150

WEIGHT, KG 0,770

MANUFACTURER [NB](#)