

KBS 30G NB

Linear bushing

TYPE: Shaft guidance systems, Linear bushing, Standard, Close type, Type KB, European standard, Corrosion resistance, Plastic cage (NB)

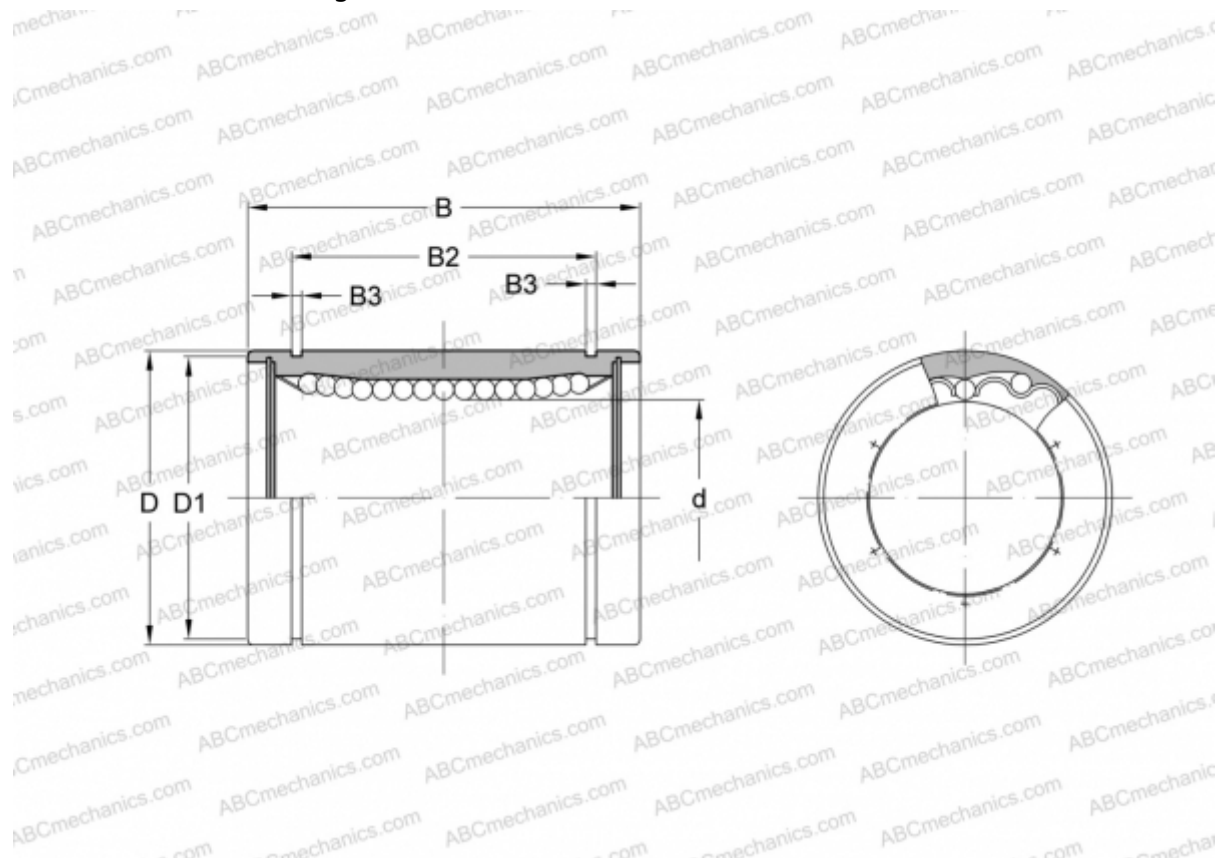

Technical specification

DIMENSIONS, MM

d	30,000
D	47,000
B	68,000
D1	44,500
B2	52,100
B3	1,850

WEIGHT, KG 0,360

MANUFACTURER [NB](#)