

## KBS 50G NB

Linear bushing

TYPE: Shaft guidance systems, Linear bushing, Standard, Close type, Type KB, European standard, Corrosion resistance, Plastic cage (NB)

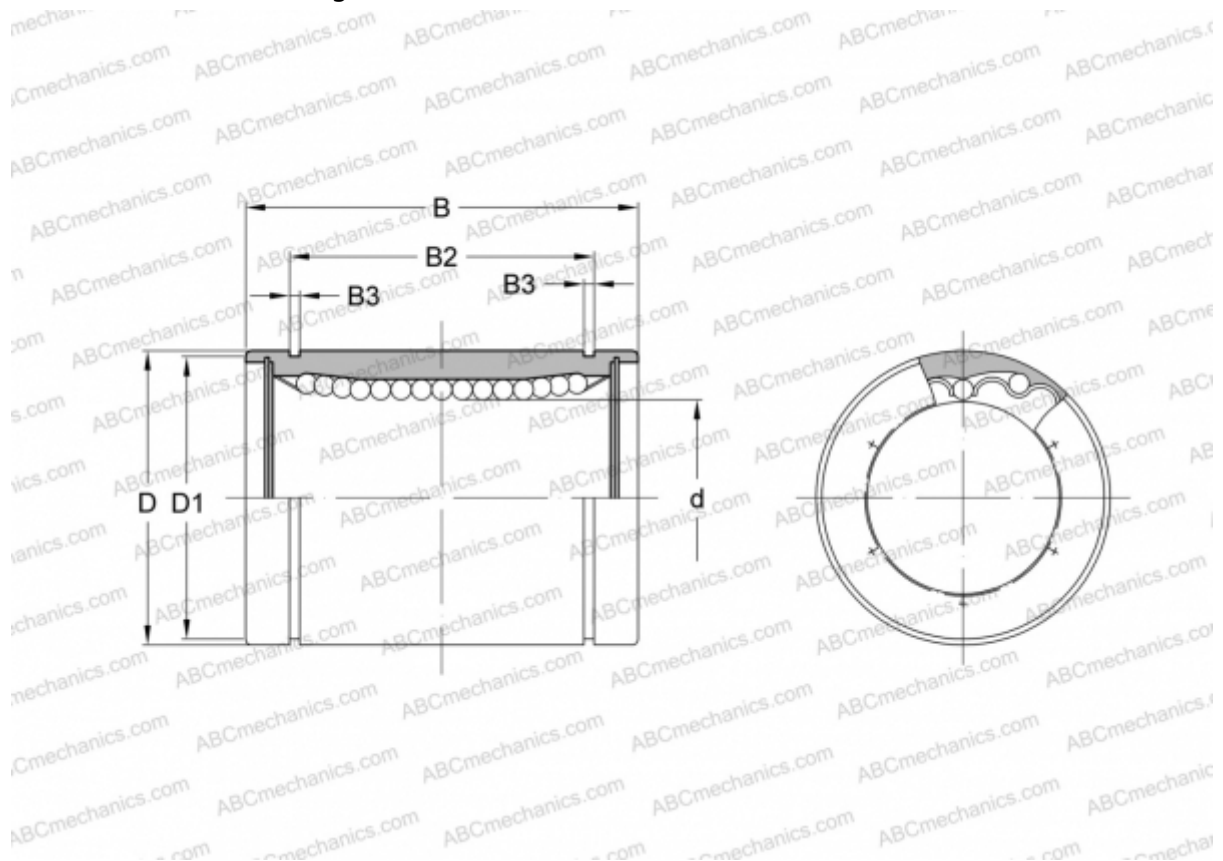

### Technical specification

#### DIMENSIONS, MM

d	50,000
D	75,000
B	100,000
D1	72,000
B2	77,600
B3	2,650

**WEIGHT, KG** 1,250

**MANUFACTURER** [NB](#)