

KB 12-AJ NB

Linear bushing

TYPE: Shaft guidance systems, Linear bushing, Standard, Adjustable type, Type KB..AJ, European standard, Steel cage (NB)

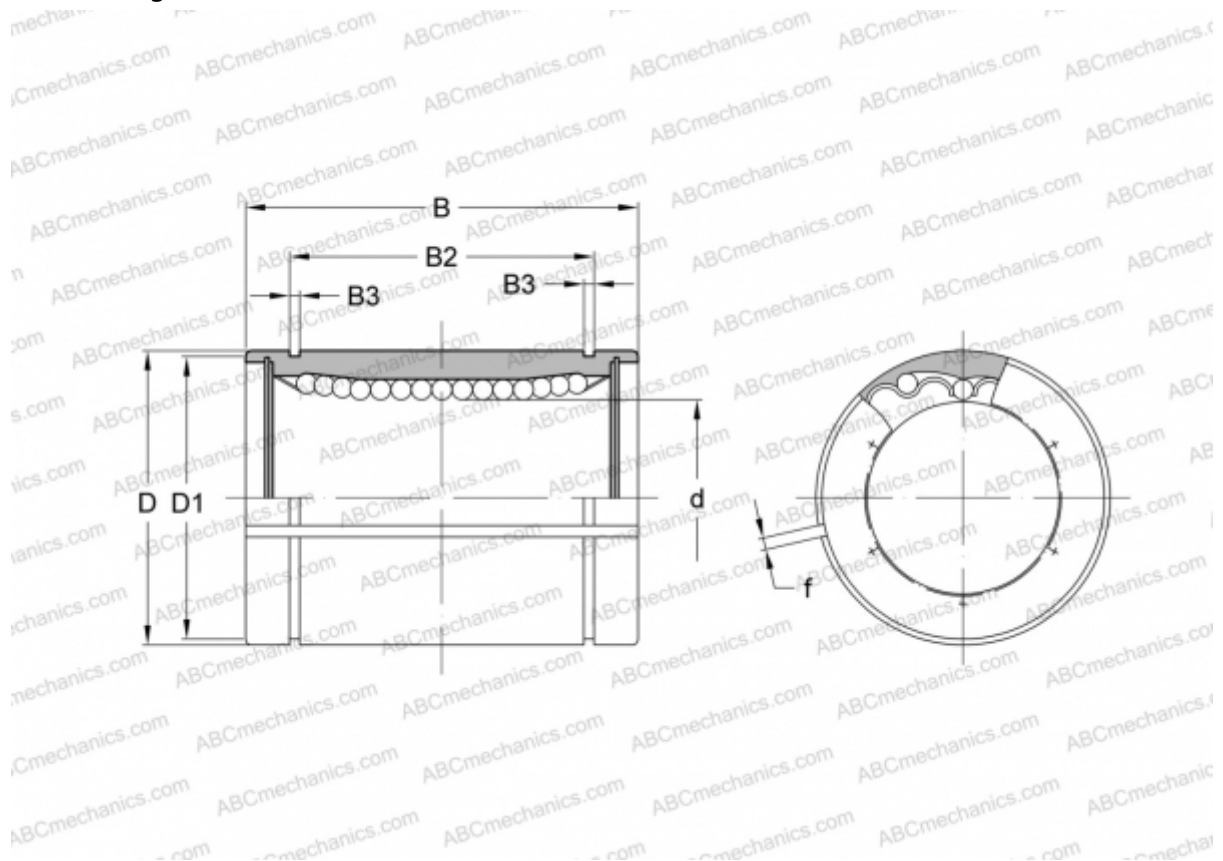

Technical specification

DIMENSIONS, MM

d	12,000
D	22,000
B	32,000
D1	21,000
B2	22,900
B3	1,300
f	1,500

WEIGHT, KG 0,044

MANUFACTURER [NB](#)