

KB 60-AJ NB

Linear bushing

TYPE: Shaft guidance systems, Linear bushing, Standard, Adjustable type, Type KB..AJ, European standard, Steel cage (NB)

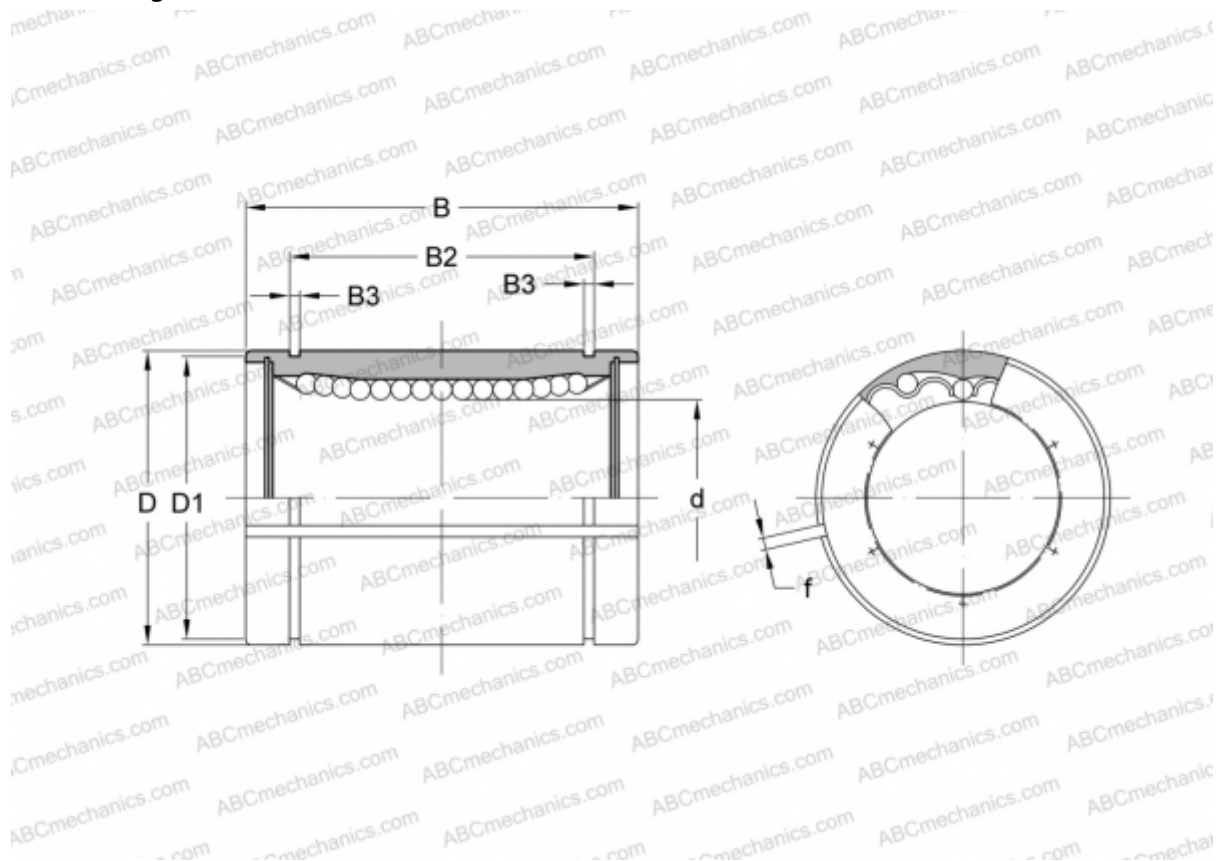

Technical specification

DIMENSIONS, MM

d	60,000
D	90,000
B	125,000
D1	86,500
B2	101,700
B3	3,150
f	3,000

WEIGHT, KG 2,170

MANUFACTURER [NB](#)