

KB10G-AJ NB

Linear bushing

TYPE: Shaft guidance systems, Linear bushing, Standard, Adjustable type, Type KB..AJ, European standard, Plastic cage (NB)

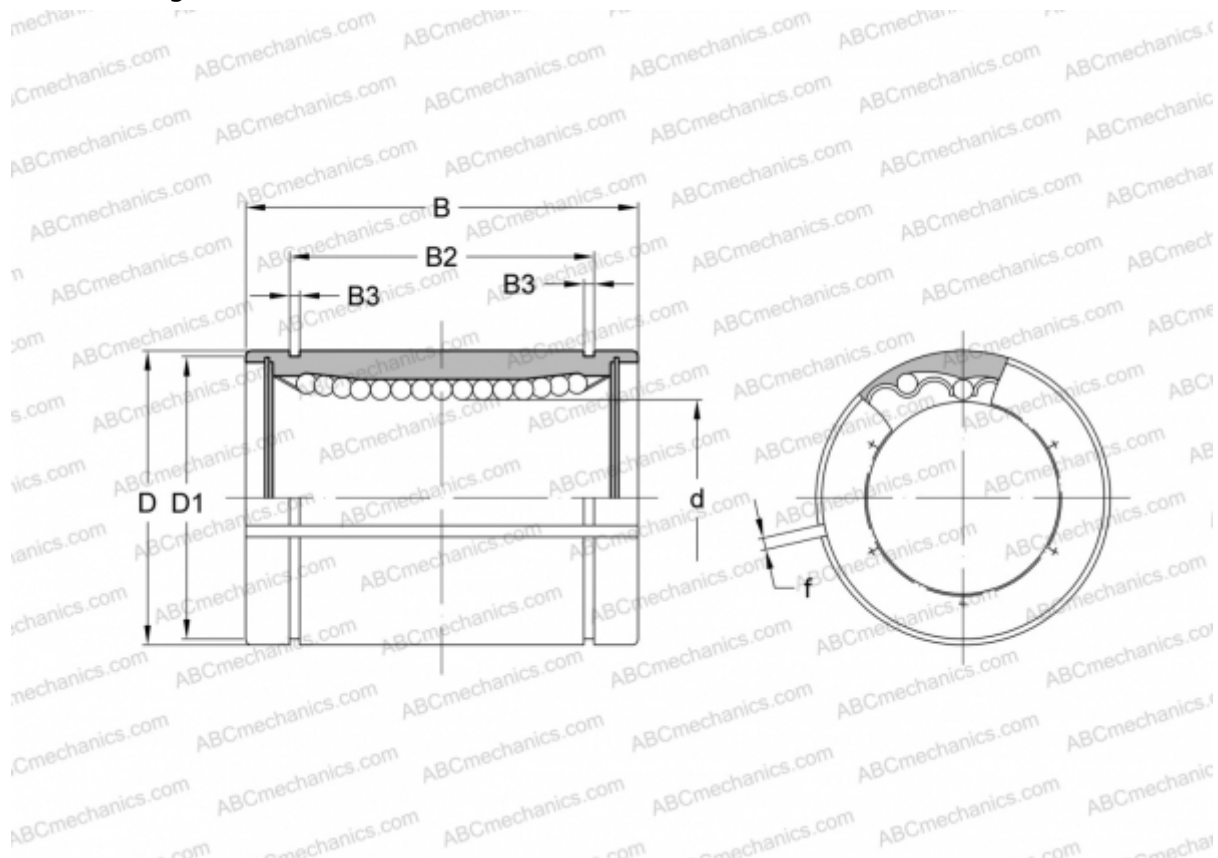

Technical specification

DIMENSIONS, MM

d	10,000
D	19,000
B	29,000
D1	18,000
B2	22,000
B3	1,300
f	1,000

WEIGHT, KG 0,029

MANUFACTURER [NB](#)