

KB 25G-AJ NB

Linear bushing

TYPE: Shaft guidance systems, Linear bushing, Standard, Adjustable type, Type KB..AJ, European standard, Plastic cage (NB)

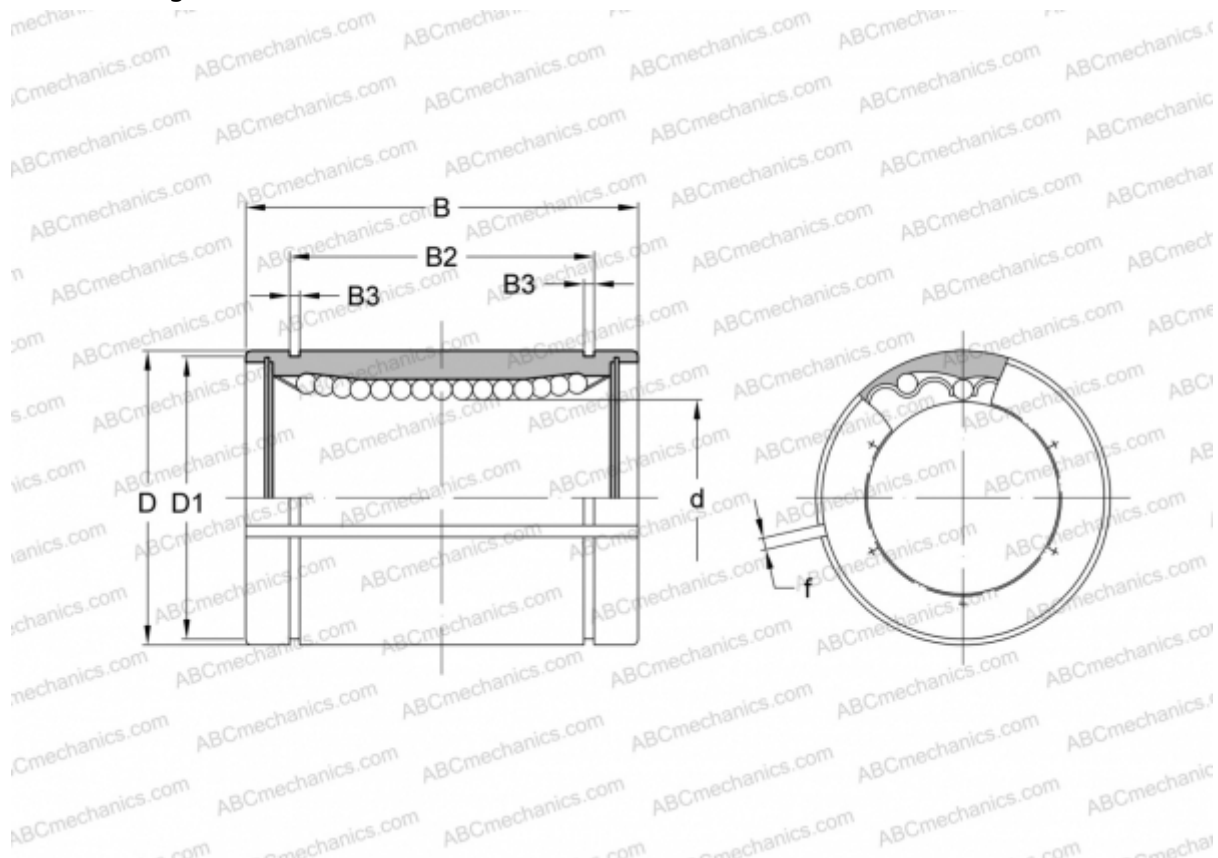

Technical specification

DIMENSIONS, MM

d	25,000
D	40,000
B	58,000
D1	37,500
B2	44,100
B3	1,850
f	2,000

WEIGHT, KG 0,230

MANUFACTURER [NB](#)