

KB 50G-AJ NB

Linear bushing

TYPE: Shaft guidance systems, Linear bushing, Standard, Adjustable type, Type KB..AJ, European standard, Plastic cage (NB)

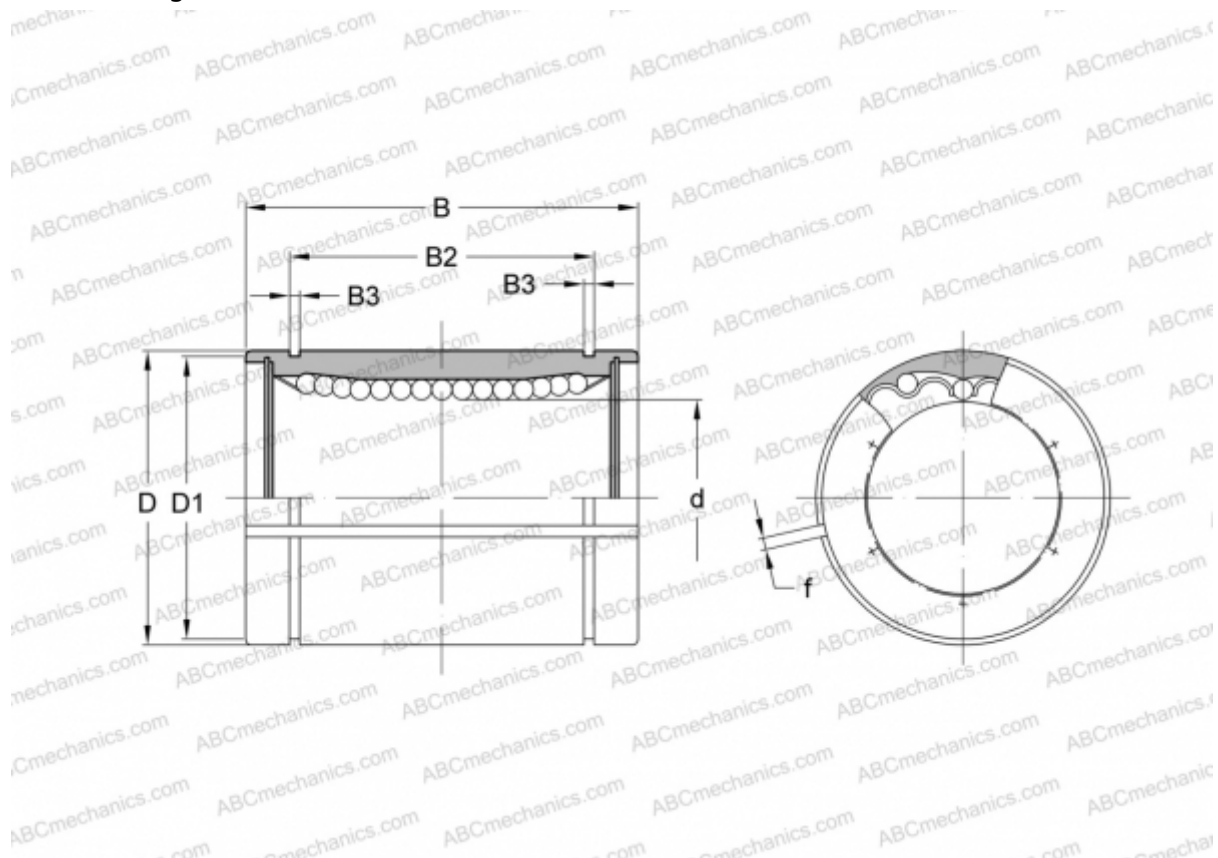

Technical specification

DIMENSIONS, MM

d	50,000
D	75,000
B	100,000
D1	72,000
B2	77,600
B3	2,650
f	3,000

WEIGHT, KG 1,230

MANUFACTURER [NB](#)