

## KBS 8G-AJ NB

Linear bushing

TYPE: Shaft guidance systems, Linear bushing, Standard, Adjustable type, Type KB..AJ, European standard, Corrosion resistance, Plastic cage (NB)

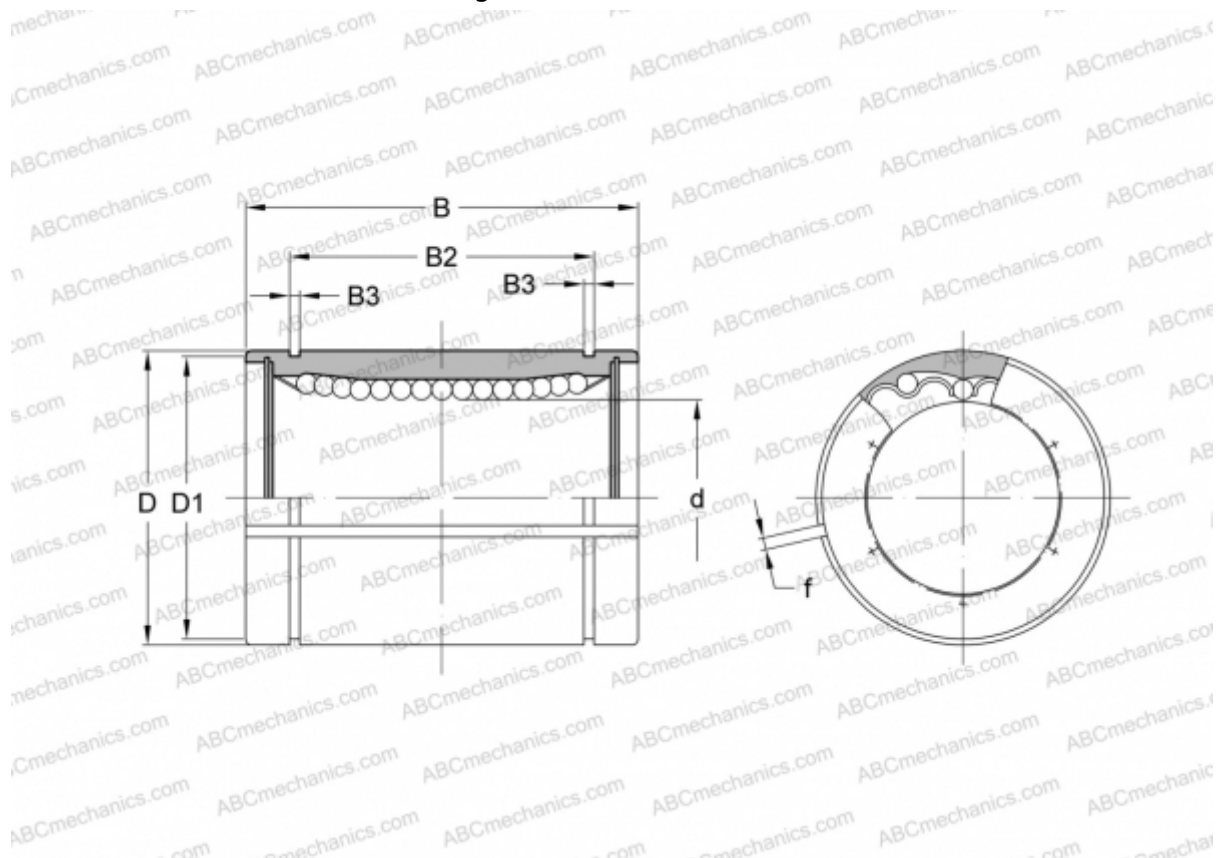

### Technical specification

#### DIMENSIONS, MM

d	8,000
D	16,000
B	25,000
D1	15,200
B2	16,500
B3	1,100
f	1,000

**WEIGHT, KG** 0,020

**MANUFACTURER** [NB](#)