

KBS 16G-AJ NB

Linear bushing

TYPE: Shaft guidance systems, Linear bushing, Standard, Adjustable type, Type KB..AJ, European standard, Corrosion resistance, Plastic cage (NB)

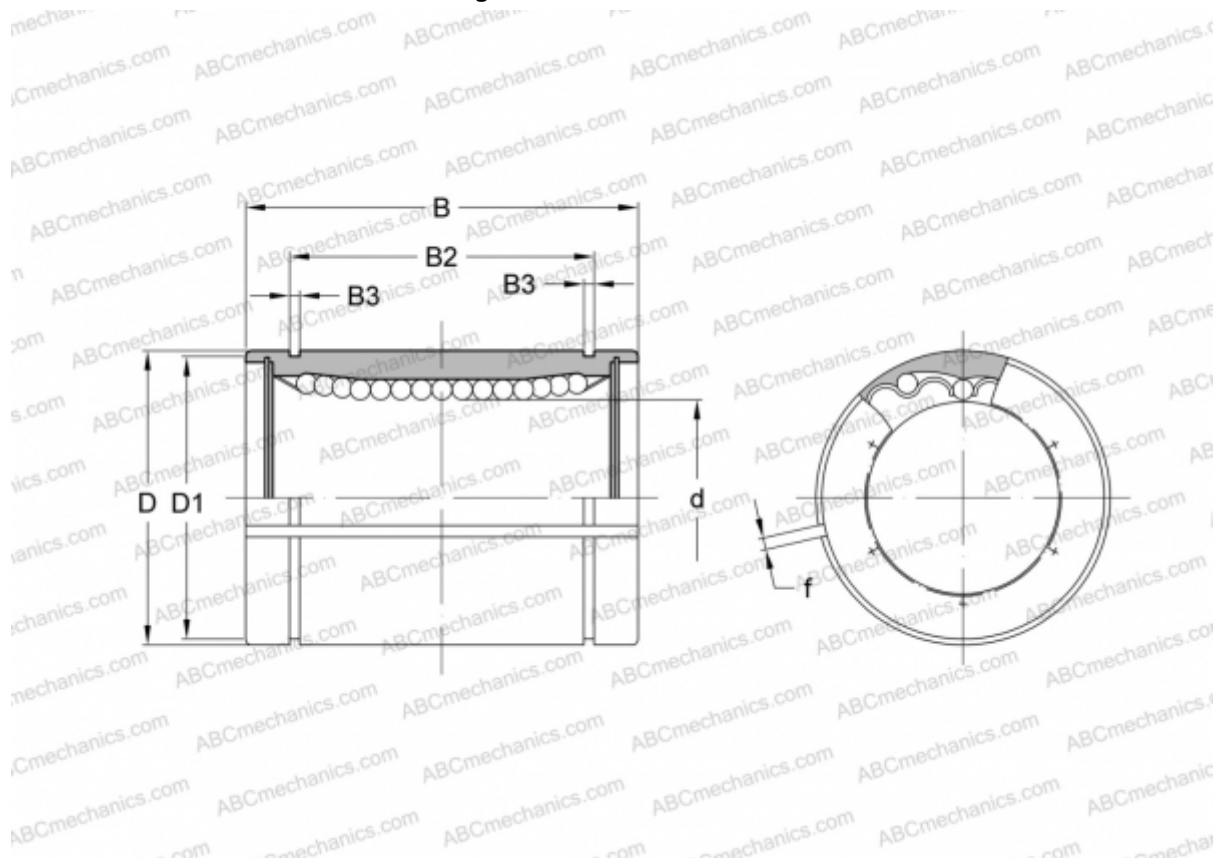

Technical specification

DIMENSIONS, MM

d	16,000
D	26,000
B	36,000
D1	24,900
B2	24,900
B3	1,300
f	1,500

WEIGHT, KG 0,059

MANUFACTURER [NB](#)