

KBS 40G-AJ NB

Linear bushing

TYPE: Shaft guidance systems, Linear bushing, Standard, Adjustable type, Type KB..AJ, European standard, Corrosion resistance, Plastic cage (NB)

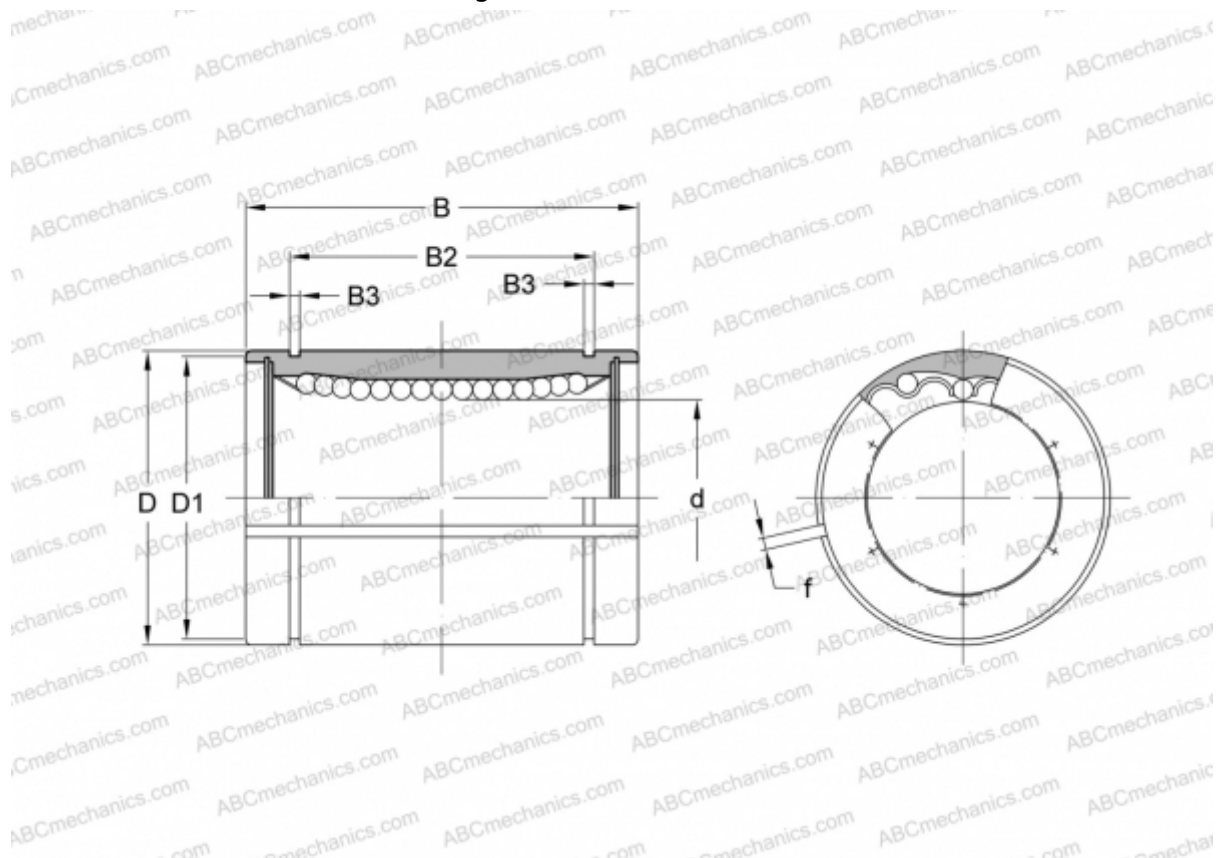

Technical specification

DIMENSIONS, MM

d	40,000
D	62,000
B	80,000
D1	59,000
B2	60,600
B3	2,150
f	3,000

WEIGHT, KG 0,758

MANUFACTURER [NB](#)