

## KB 12G-OP

Linear bushing

TYPE: Shaft guidance systems, Linear bushing, Standard, Open type for support rail, Type KB..OP, European standard, Plastic cage (NB)

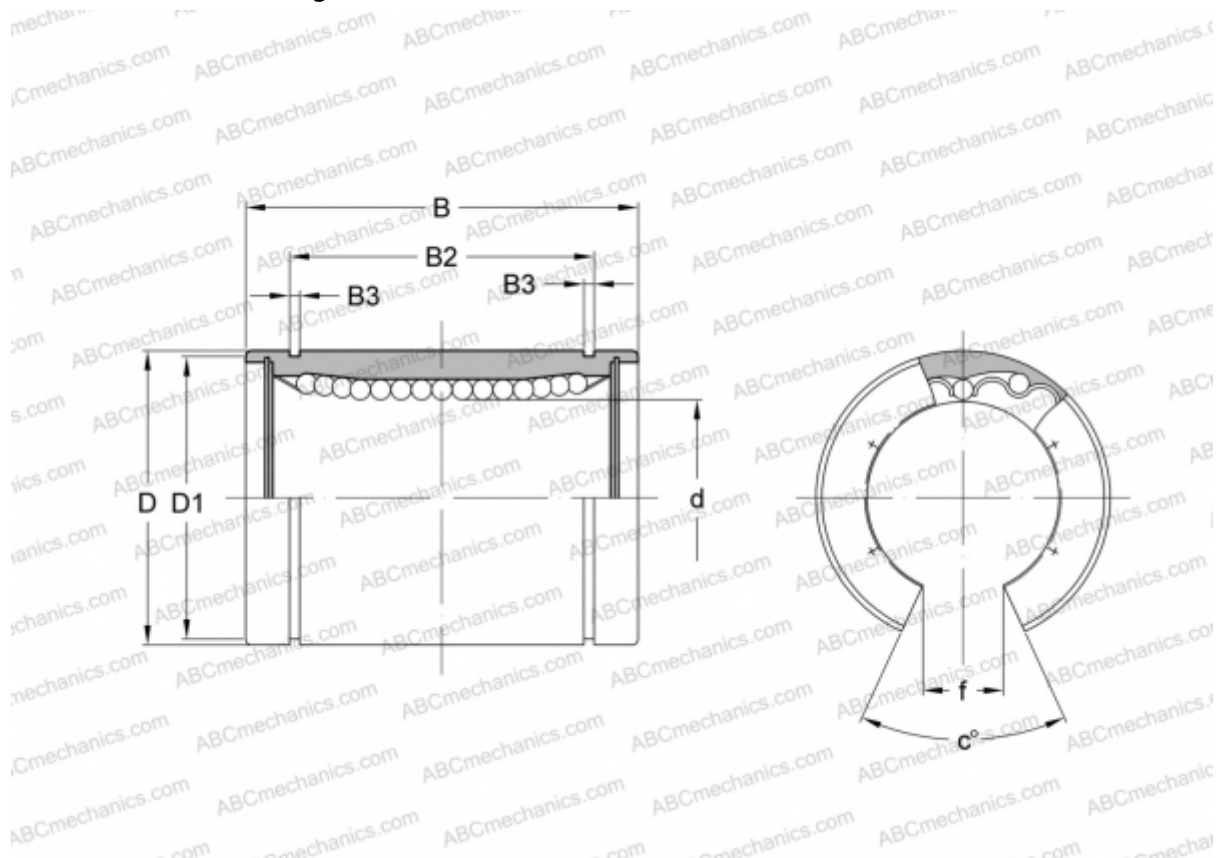

### Technical specification

#### DIMENSIONS, MM

d	12,000
D	22,000
B	32,000
D1	21,000
B2	22,900
B3	1,300
f	7,500
c	78

**WEIGHT, KG** 0,035