

KBS 20-OP

Linear bushing

TYPE: Shaft guidance systems, Linear bushing, Standard, Open type for support rail, Type KB..OP, European standard, Corrosion resistance, Stainless steel cage (NB)

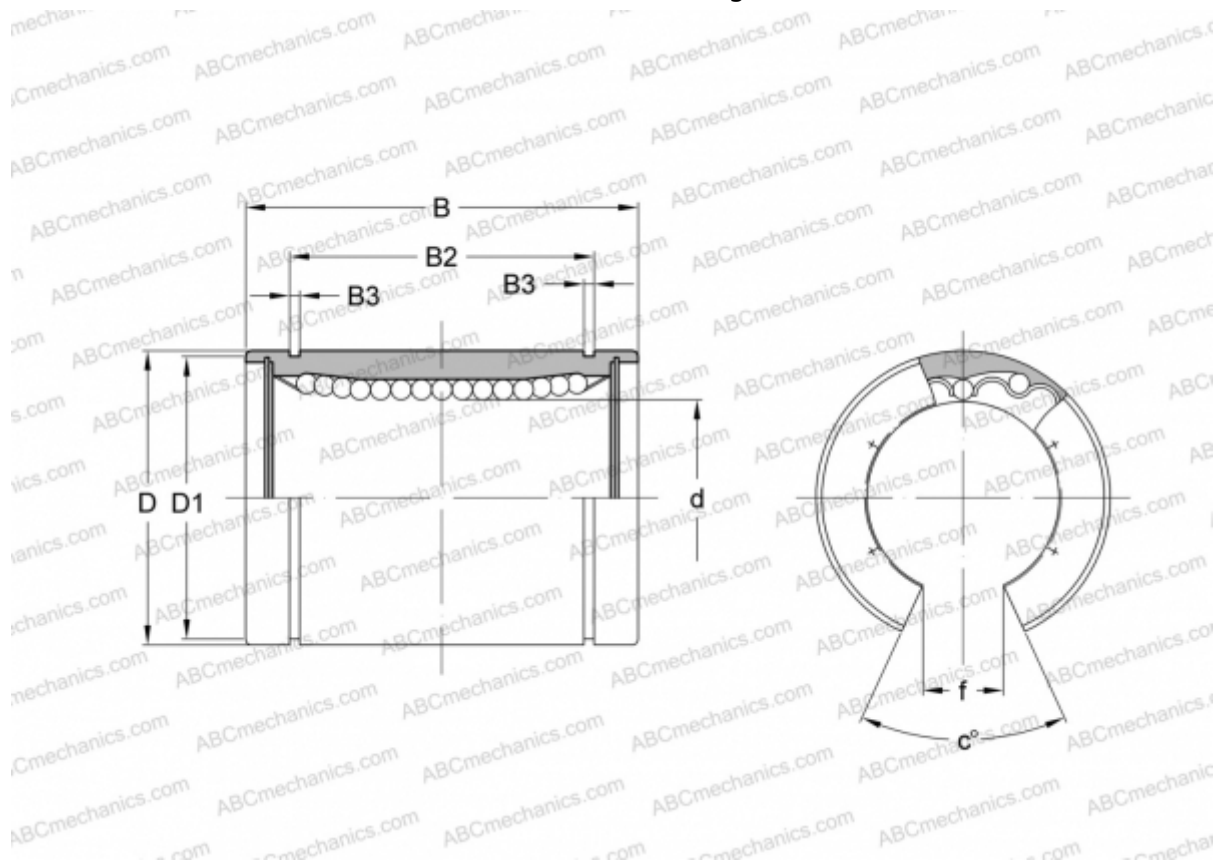

Technical specification

DIMENSIONS, MM

d	20,000
D	32,000
B	45,000
D1	30,300
B2	31,500
B3	1,600
f	10,000
c	60

WEIGHT, KG 0,084