

KBS 30-OP

Linear bushing

TYPE: Shaft guidance systems, Linear bushing, Standard, Open type for support rail, Type KB..OP, European standard, Corrosion resistance, Stainless steel cage (NB)

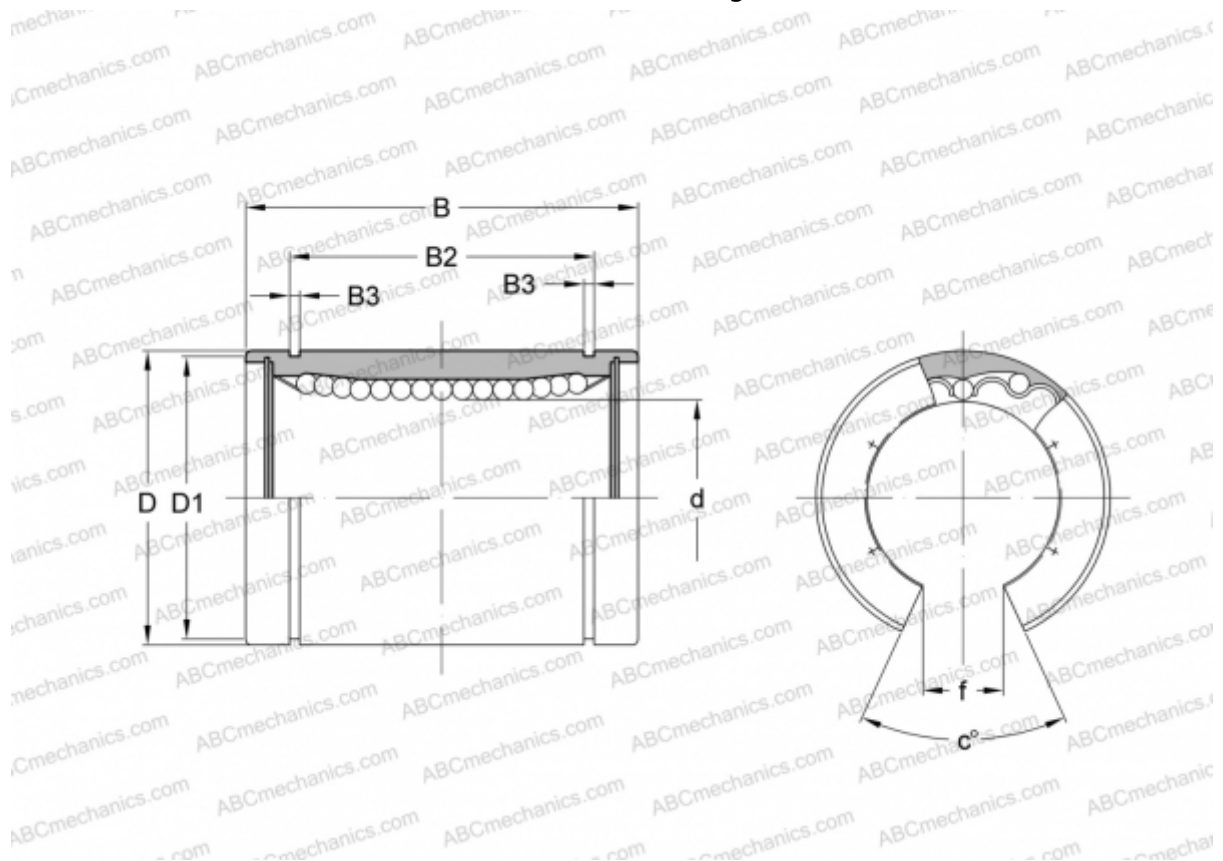

Technical specification

DIMENSIONS, MM

d	30,000
D	47,000
B	68,000
D1	44,500
B2	52,100
B3	1,850
f	12,500
c	50

WEIGHT, KG 0,309