

KBS 40-OP

Linear bushing

TYPE: Shaft guidance systems, Linear bushing, Standard, Open type for support rail, Type KB..OP, European standard, Corrosion resistance, Stainless steel cage (NB)

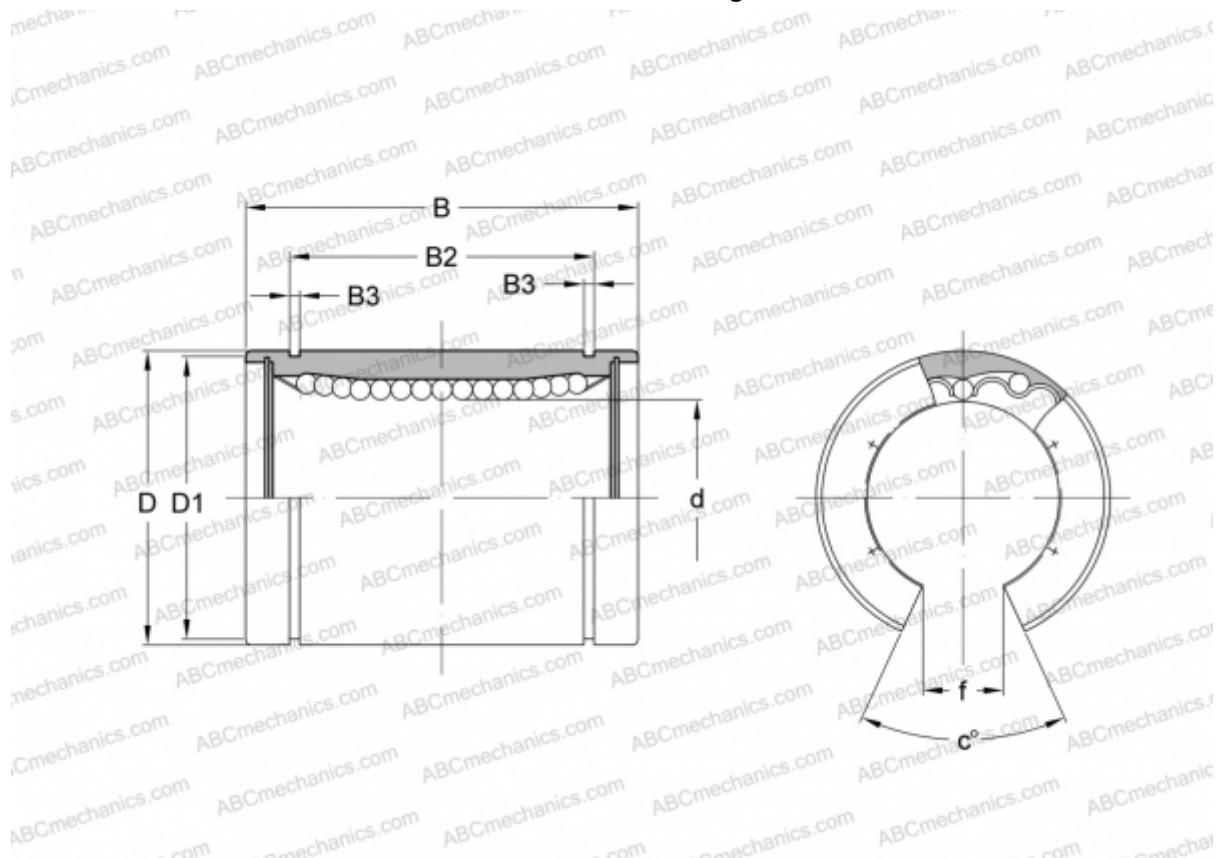

Technical specification

DIMENSIONS, MM

d	40,000
D	62,000
B	80,000
D1	59,000
B2	60,600
B3	2,150
f	16,800
c	50

WEIGHT, KG 0,665