

KBS 10G-OP

Linear bushing

TYPE: Shaft guidance systems, Linear bushing, Standard, Open type for support rail, Type KB..OP, European standard, Corrosion resistance, Plastic cage (NB)

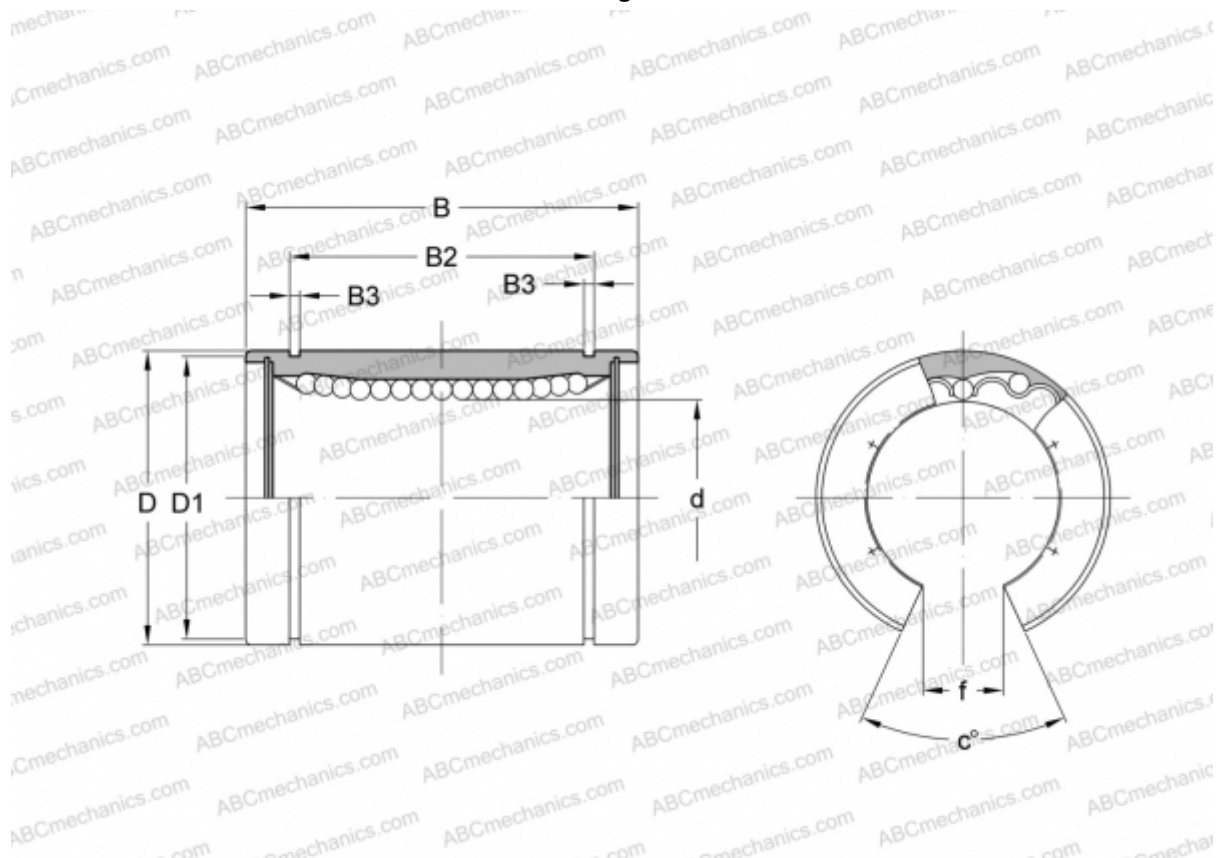

Technical specification

DIMENSIONS, MM

d	10,000
D	19,000
B	29,000
D1	18,000
B2	22,000
B3	1,300
f	6,800
c	80

WEIGHT, KG 0,023