

## KBS 20G-OP

Linear bushing

TYPE: Shaft guidance systems, Linear bushing, Standard, Open type for support rail, Type KB..OP, European standard, Corrosion resistance, Plastic cage (NB)

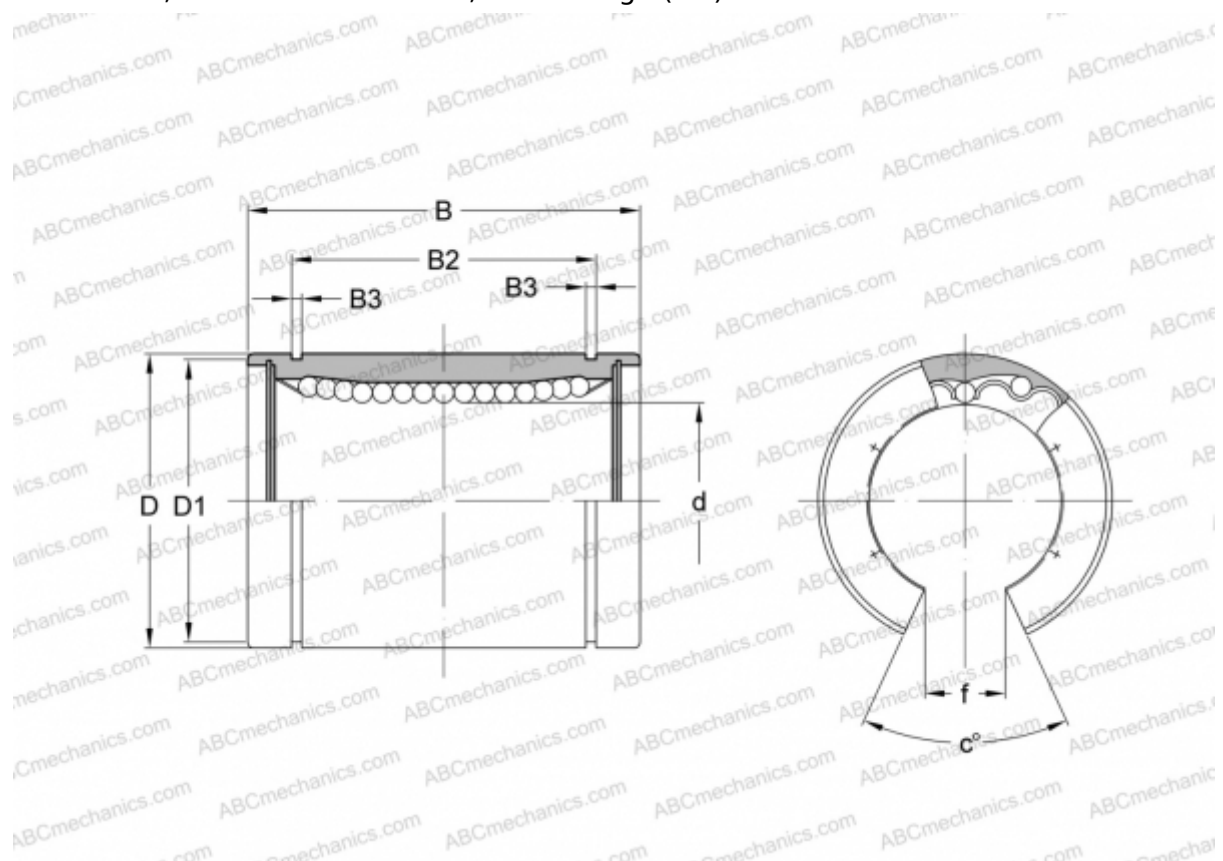

### Technical specification

#### DIMENSIONS, MM

d	20,000
D	32,000
B	45,000
D1	30,300
B2	31,500
B3	1,600
f	10,000
c	60

**WEIGHT, KG** 0,084