

KB 16W NB

Linear bushing

TYPE: Shaft guidance systems, Linear bushing, Standard, Close type, double length, Type KB..W, European standard, Steel cage (NB)

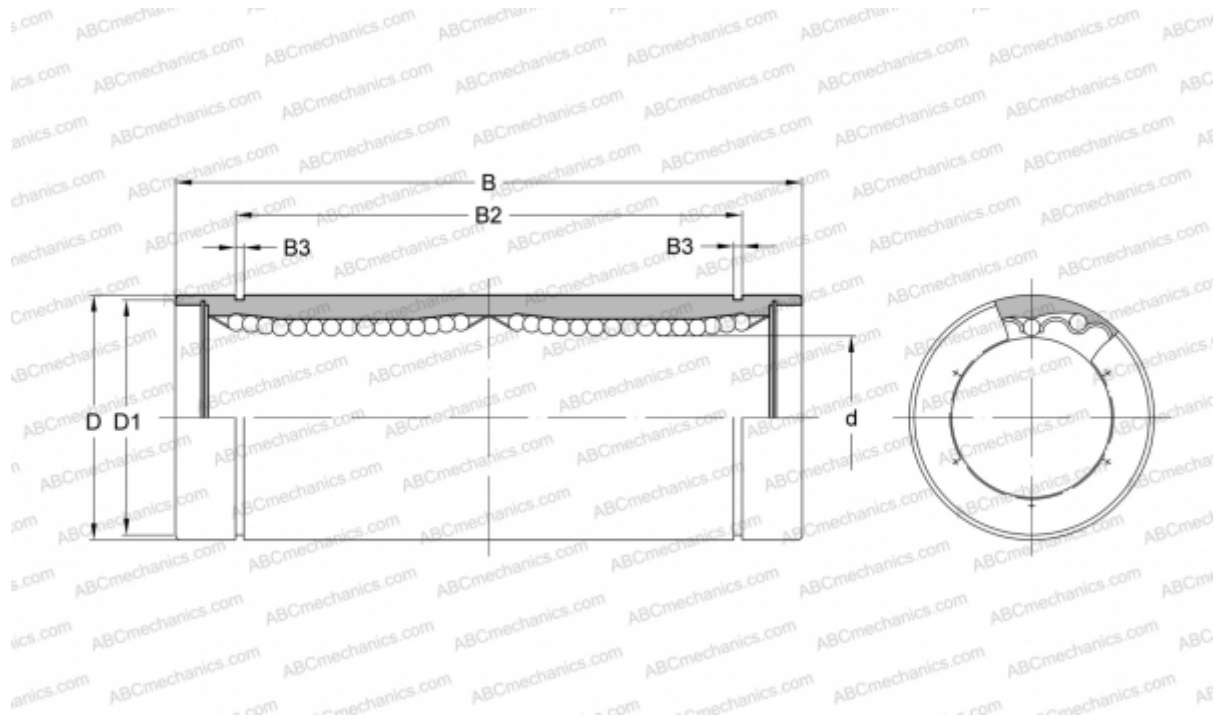

Technical specification

DIMENSIONS, MM

d	16,000
D	26,000
B	68,000
D1	24,900
B2	49,800
B3	1,300

WEIGHT, KG 0,115

MANUFACTURER [NB](#)