

KB 12GW NB

Linear bushing

TYPE: Shaft guidance systems, Linear bushing, Standard, Close type, double length, Type KB..W, European standard, Plastic cage (NB)

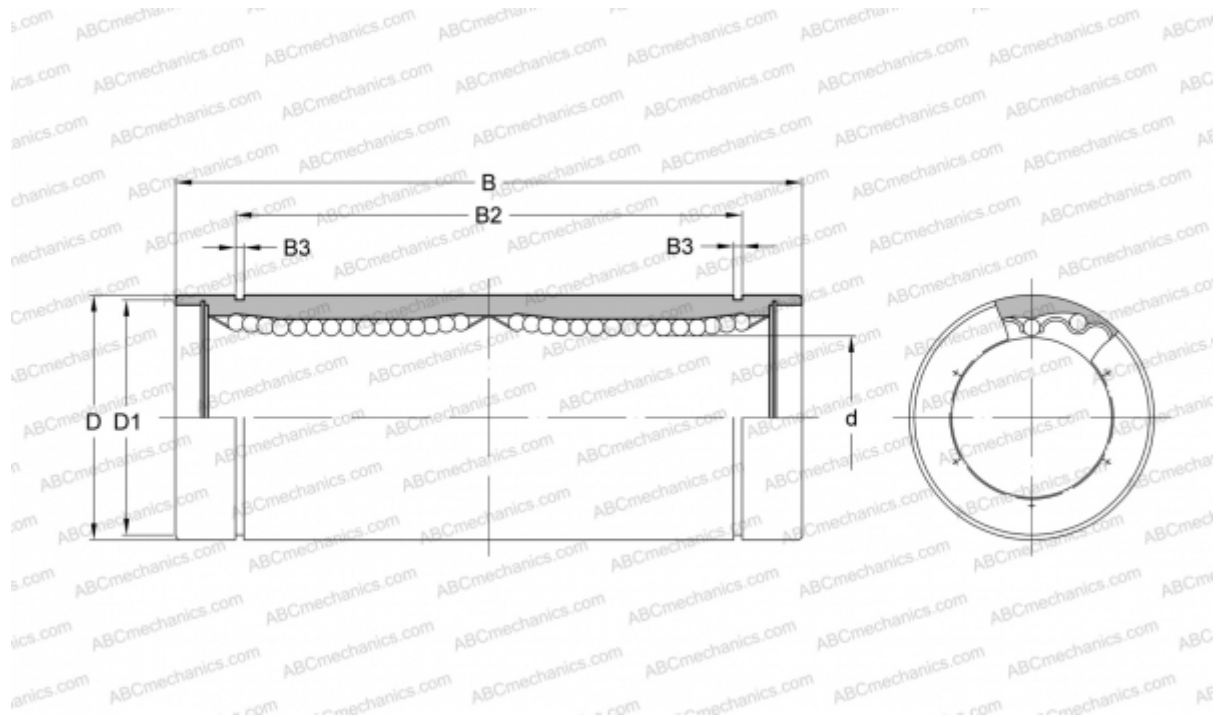

Technical specification

DIMENSIONS, MM

d	12,000
D	22,000
B	61,000
D1	21,000
B2	45,800
B3	1,300

WEIGHT, KG 0,080

MANUFACTURER [NB](#)