

## KB 60GW NB

Linear bushing

TYPE: Shaft guidance systems, Linear bushing, Standard, Close type, double length, Type KB..W, European standard, Plastic cage (NB)

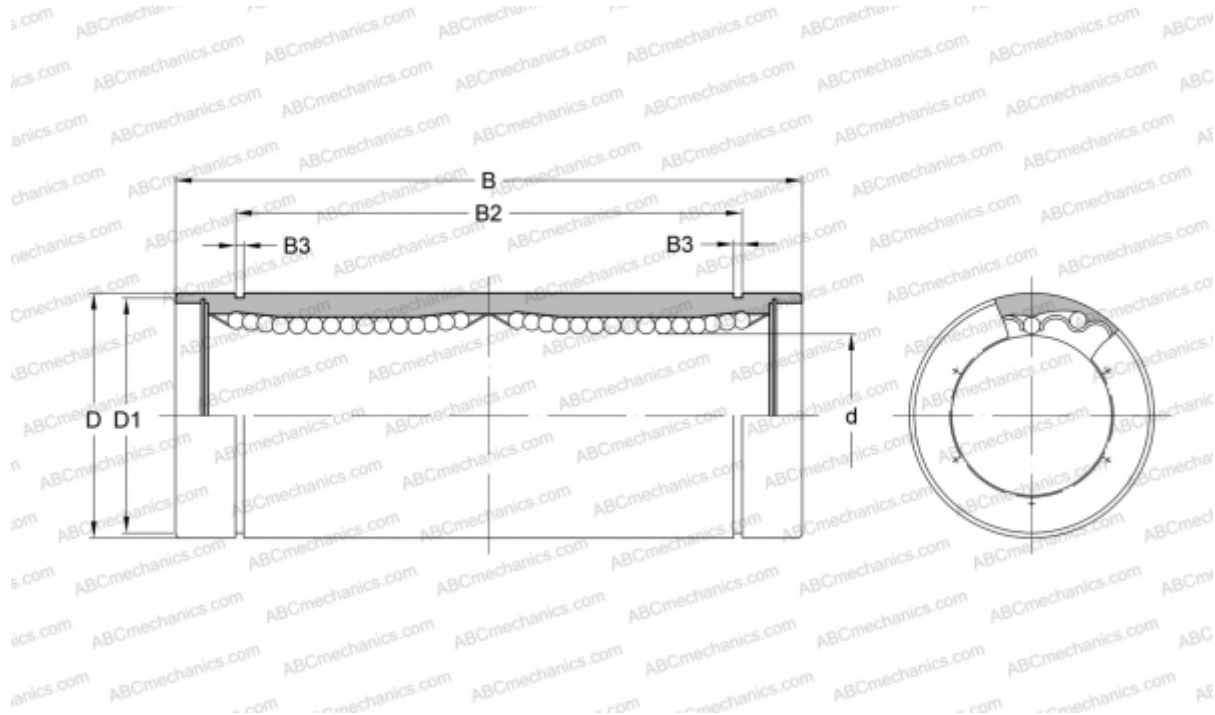

### Technical specification

#### DIMENSIONS, MM

d	60,000
D	90,000
B	209,000
D1	86,500
B2	170,000
B3	3,150

**WEIGHT, KG** 3,920

**MANUFACTURER** [NB](#)