

KBS 40W NB

Linear bushing

TYPE: Shaft guidance systems, Linear bushing, Standard, Close type, double length, Type KB..W, European standard, Corrosion resistance, Stainless steel cage (NB)

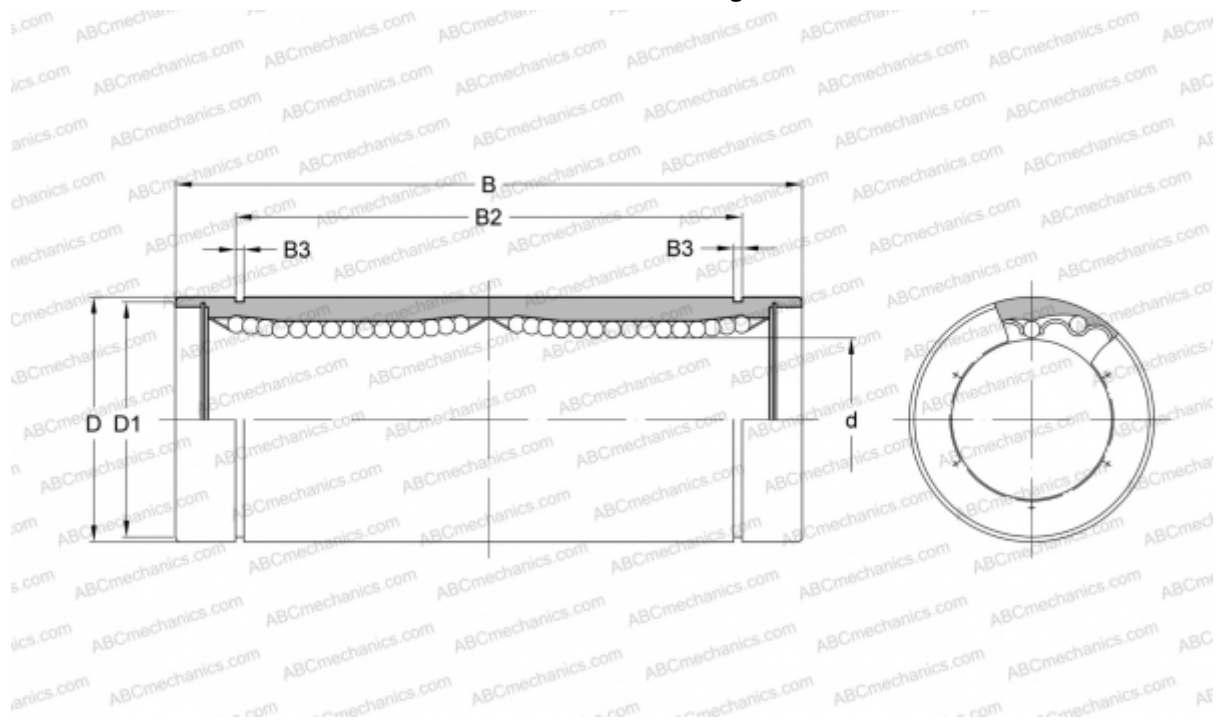

Technical specification

DIMENSIONS, MM

d	40,000
D	62,000
B	151,000
D1	59,000
B2	121,200
B3	2,150

WEIGHT, KG 1,400

MANUFACTURER [NB](#)